



ES 1000

with unique free standing control console for more efficient operation

BAND RESAW

- Two banks of feed units each with 2 rollers – one as a fence, the other as a feed
- Left or right hand fence
- Four roller feed option (Models ES2 and ES4)
- Pressure or standard saw guides
- Hydraulic saw tensioning
- Free-standing control console giving digital display of:
 - selected feed speed
 - automatically controlled feed and fence unit positions
 - running total of timber throughput
 - running time
- Indication of true running and positioning of saw
- Safety switch for saw changing
- Self centering feature
- Canting table (option Models ES3 and ES4)
- Twin liner and directly opposed variant machines also available

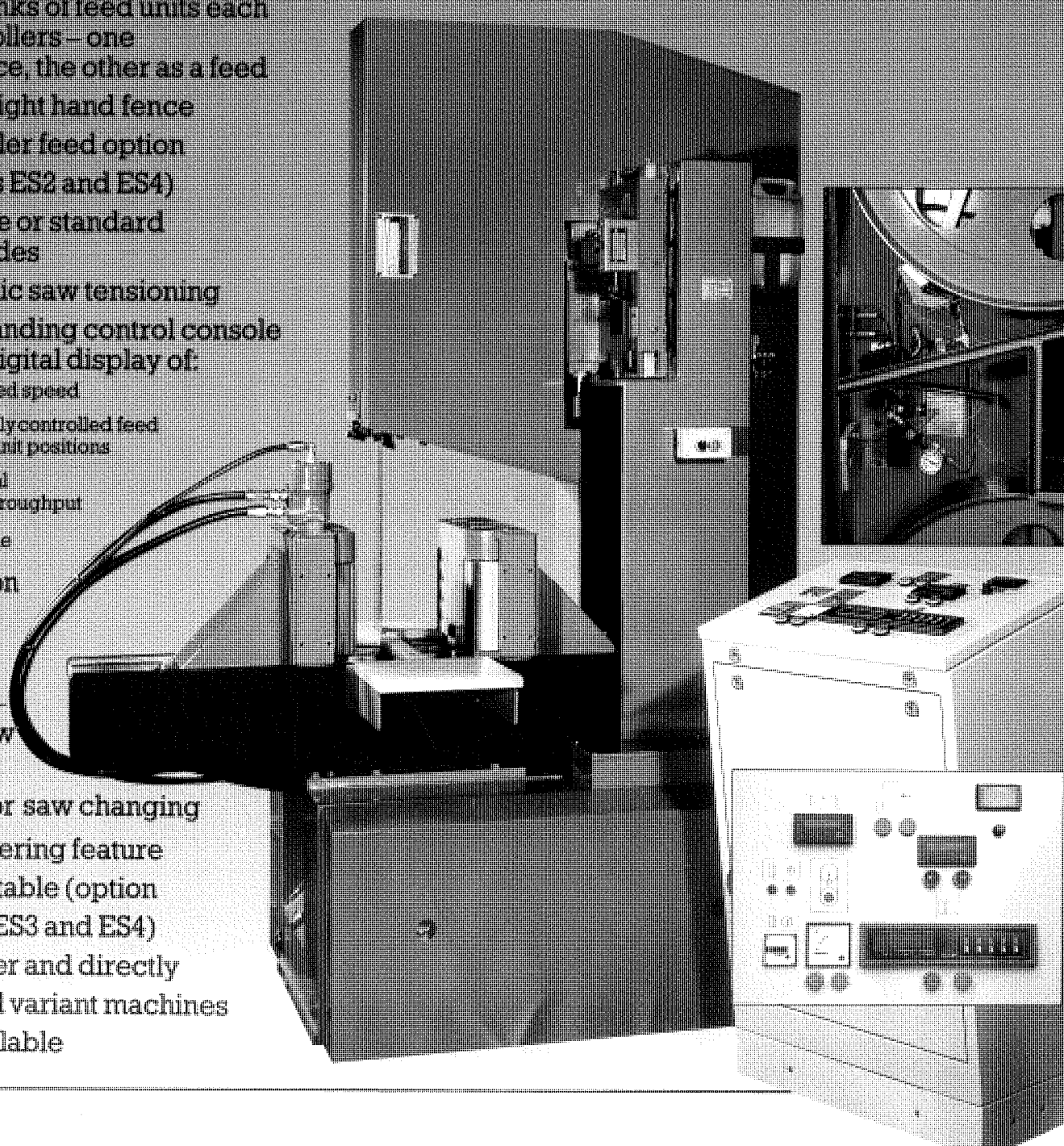

CAUTION!

1. READ AND UNDERSTAND OPERATORS MANUAL BEFORE OPERATING MACHINE
2. ALWAYS DISCONNECT POWER AND LOCK MAIN ISOLATOR BEFORE DOING MAINTENANCE SERVICE OR CLEANING
DO NOT ATTEMPT TO CLEAN OR OIL MACHINE WHILST IN MOTION
3. KEEP ALL GUARDS, COVERS AND DOORS IN PLACE WHEN MACHINE IS RUNNING AND REPLACE CORRECTLY AFTER SETTING UP MACHINE
4. DO NOT PLACE HANDS BETWEEN TIMBER AND FEED ROLLS OR TABLE ETC.

THE MACHINE IS EQUIPPED WITH GUARDS AND SAFETY DEVICES FOR OPERATOR AND MACHINE SAFETY.
CHECK MACHINE BEFORE STARTING OPERATION.

INDEX

PAGE	TECHNICAL DATA
4	INSTALLATION
5	ELECTRICAL CONNECTIONS
5	DUST EXTRACTION
6	GENERAL MACHINE DESCRIPTION
8	CONTROL PANEL LAYOUT
11	GENERAL INSTRUCTIONS ON MACHINE OPERATION
16	SAW GUIDES
18	SAW LUBRICATION & CLEANING
18	MAIN SAW WHEEL DRIVE
20	GENERAL MAINTENANCE
22	GUIDE TO FEED SPEED
24	SPARES
25	MACHINE LIFTING POINTS
26	ASSEMBLY OF BOTTOM SAW WHEEL

SUPERSAW

1m Band Resaw Type ES

TECHNICAL DATA

WORKING HEIGHT	800mm
WHEEL DIAMETER	1000mm
SAW BLADE WIDTH	100mm MIN. 127mm MAX.
MAX _m LENGTH	1.3/4"P 138T 6134mm - [6140]
MIN _m LENGTH	1.3/4"P 135T 6001mm - [5995]
FEED SPEED	0 - 60 m/min
FEED ROLLER DIAMETER	127mm
FENCE ROLLER DIAMETER	127mm
FEED AND FENCE ROLLER DEPTH	200mm
FEED AND FENCE ROLLER CENTRES	300mm
FEED ROLLER CENTRE TO SAW (ES 1 + 2)	40mm
MAX. DISTANCE SAW TO FEED ROLLER	275mm
MAX. DISTANCE SAW TO FENCE	275mm
MAX. DISTANCE UNDER SAW GUIDE	400mm
MAIN DRIVE MOTOR	18 kW 25 H.P (STD) 22 kW 30 H.P (MAX)
FEED MOTOR	4 kW 5.5 H.P
SAW SPINDLE SPEED	750 RPM (STD)

INSTALLATION

The machine should be placed on a secure base of concrete on prepared foundations as per drawing ES/00/001.

Square pocket holes can be left for securing bolts to be grouted in when machine is finally positioned. Normally the machine will be delivered with the Bottom Saw Wheel and Main Drive Belts removed. The Saw Wheel should be mounted in the machine once it has been positioned ensuring that locating peg (1) and locking screw (2) are tightened. Positioning scraper and pad brackets to contact the wheel.

The main drive belts can be fitted at this stage, or left until final grouting has been completed.

Refer to PAGE 18.

The machine should now be levelled up by placing slate or metal packings at the corners.

Drop a plumb line across the wheel edges and check whether vertical. Adjust packings as required.

Check level across the feed and adjust as required check both levels once more.

Run grout into pocket holes to hold bolts.

DO NOT ATTEMPT TO TIGHTEN BOLTS UNTIL GROUTING HAS THOROUGHLY HARDENED.

ELECTRICAL CONNECTIONS

All work carried out on site must be done by an experienced electrician, for full details see wiring diagram. The control panel is a free standing unit and as such can be positioned to suit customer requirements. The machine is wired up to a terminal box. Mounted on the main frame. A 3m length fly lead is supplied for connecting the terminal box to the control cabinet. This cable should be positioned in a trench, with a steel plate top liner and protected to IEE recommendations.

DUST EXTRACTION

The machine must be connected to a suitable extraction system. Provision has been made for an exhaust duct to be situated under the bottom Saw Wheel with the outlet behind the machine or at the left hand side of the machine if required.

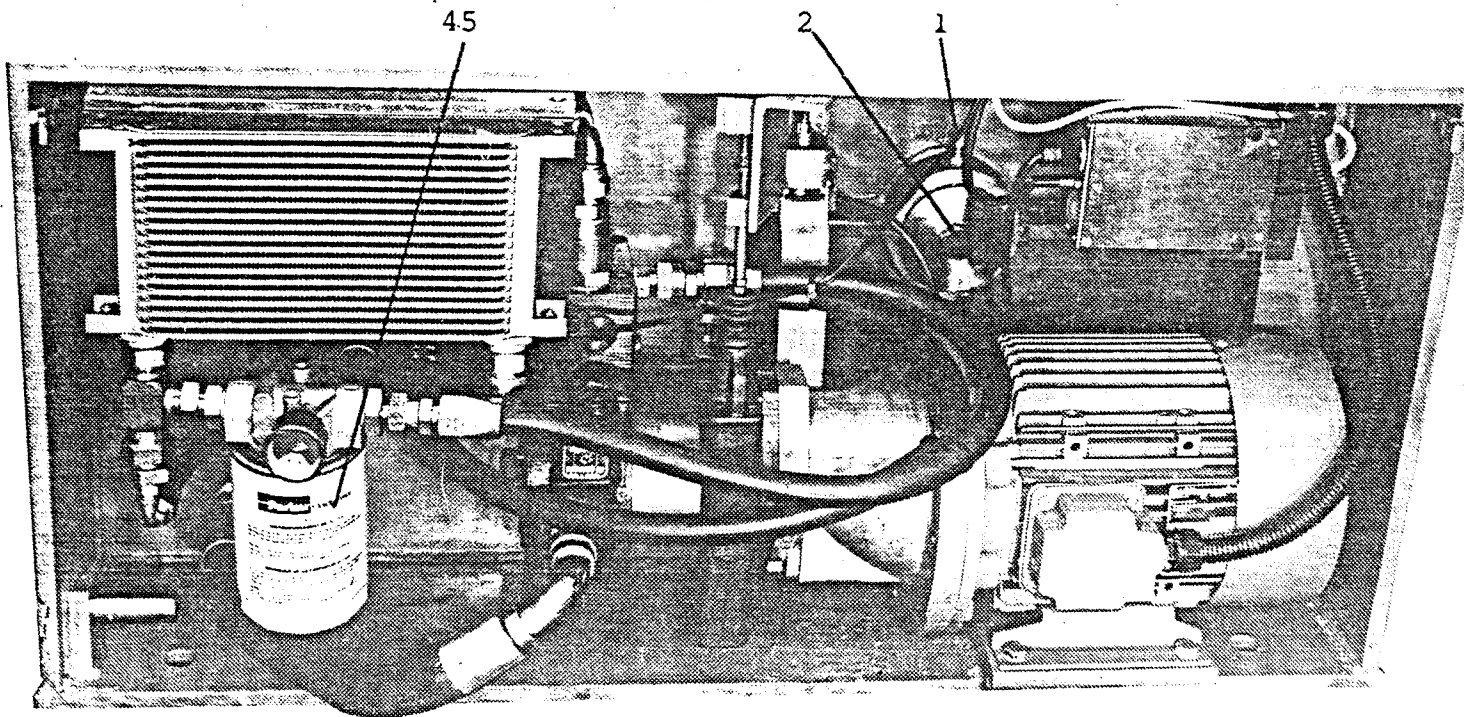

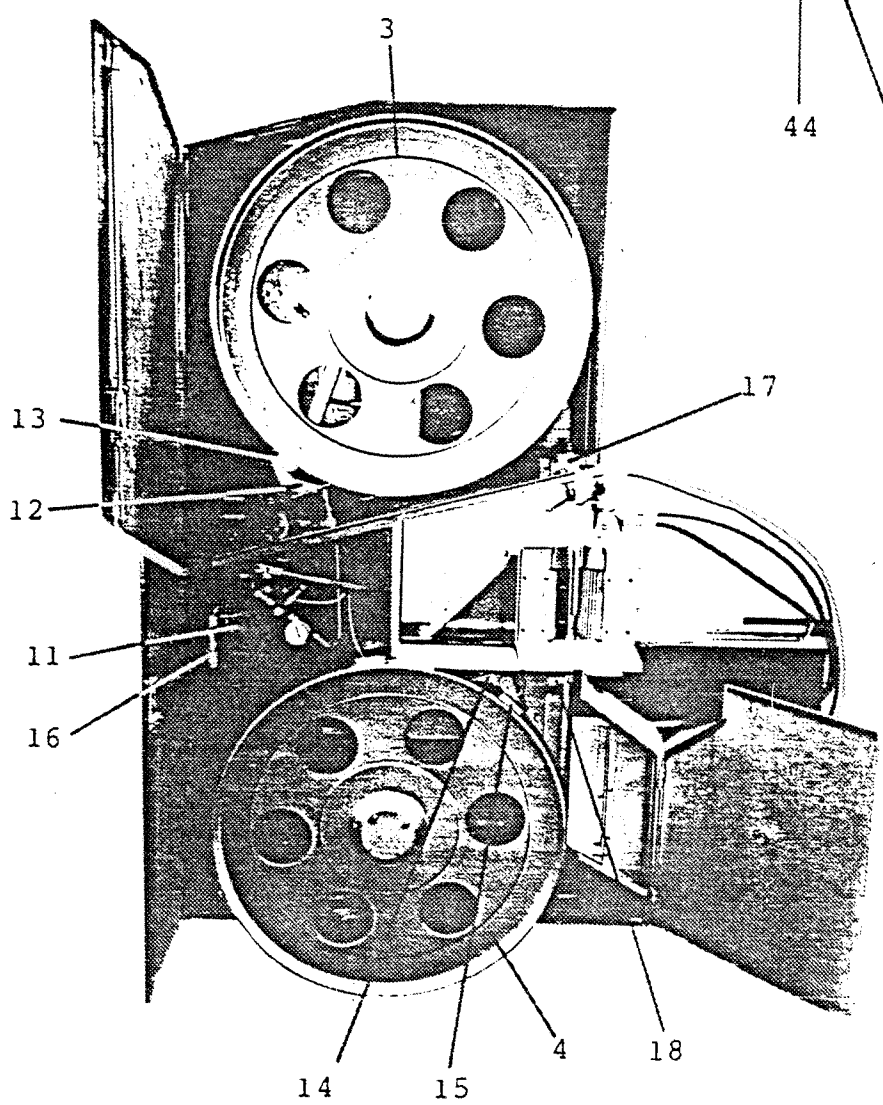
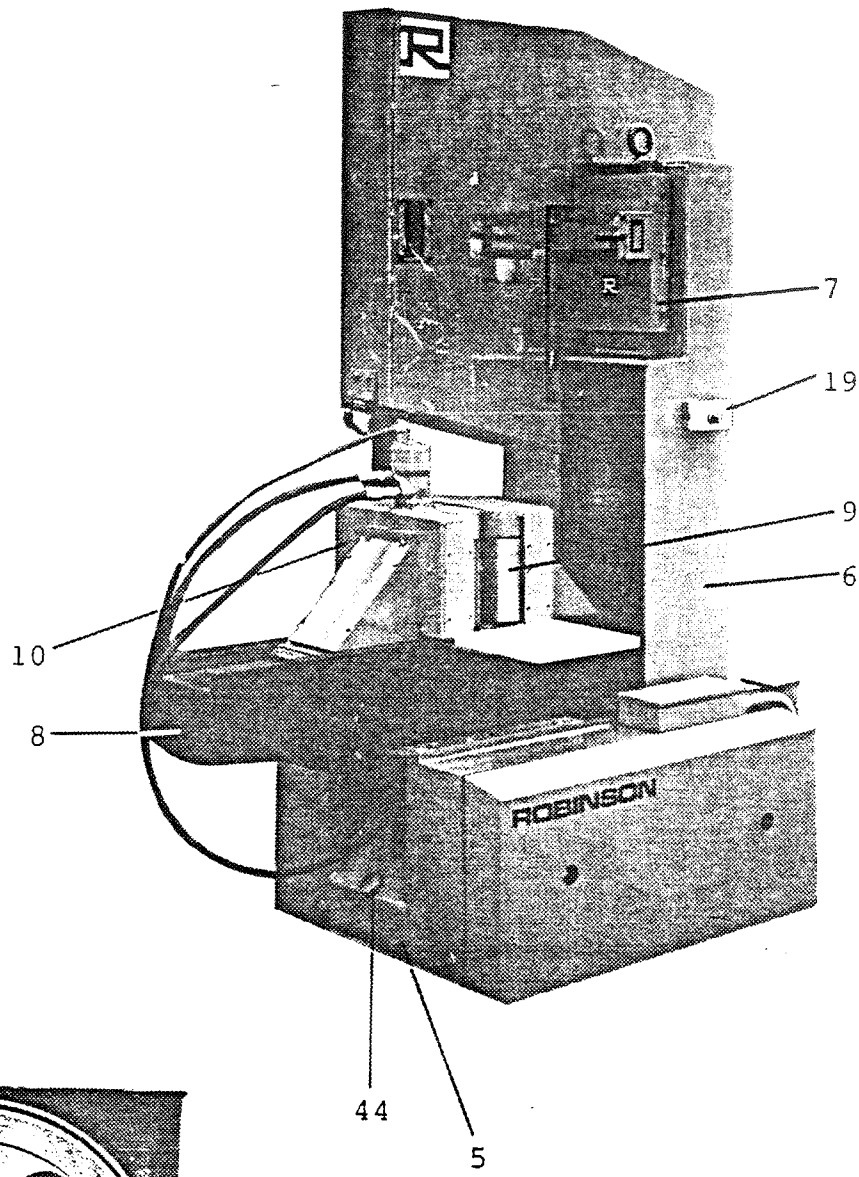

GENERAL MACHINE DESCRIPTION

3. Top Saw Wheel
4. Bottom Saw Wheel
5. Main Frame
6. Pillar
7. Top Slide
8. Feed Unit
9. Fence Rolls
10. Feed Rolls
11. Top Saw Wheel Tensioning System
12. Top Saw Wheel Scraper
13. Top Saw Wheel Cleaning Pad
14. Bottom Saw Wheel Scraper
15. Bottom Saw Wheel Cleaning Pad
16. Saw Cleaning Pad
17. Top Saw Guide
18. Bottom Saw Guide

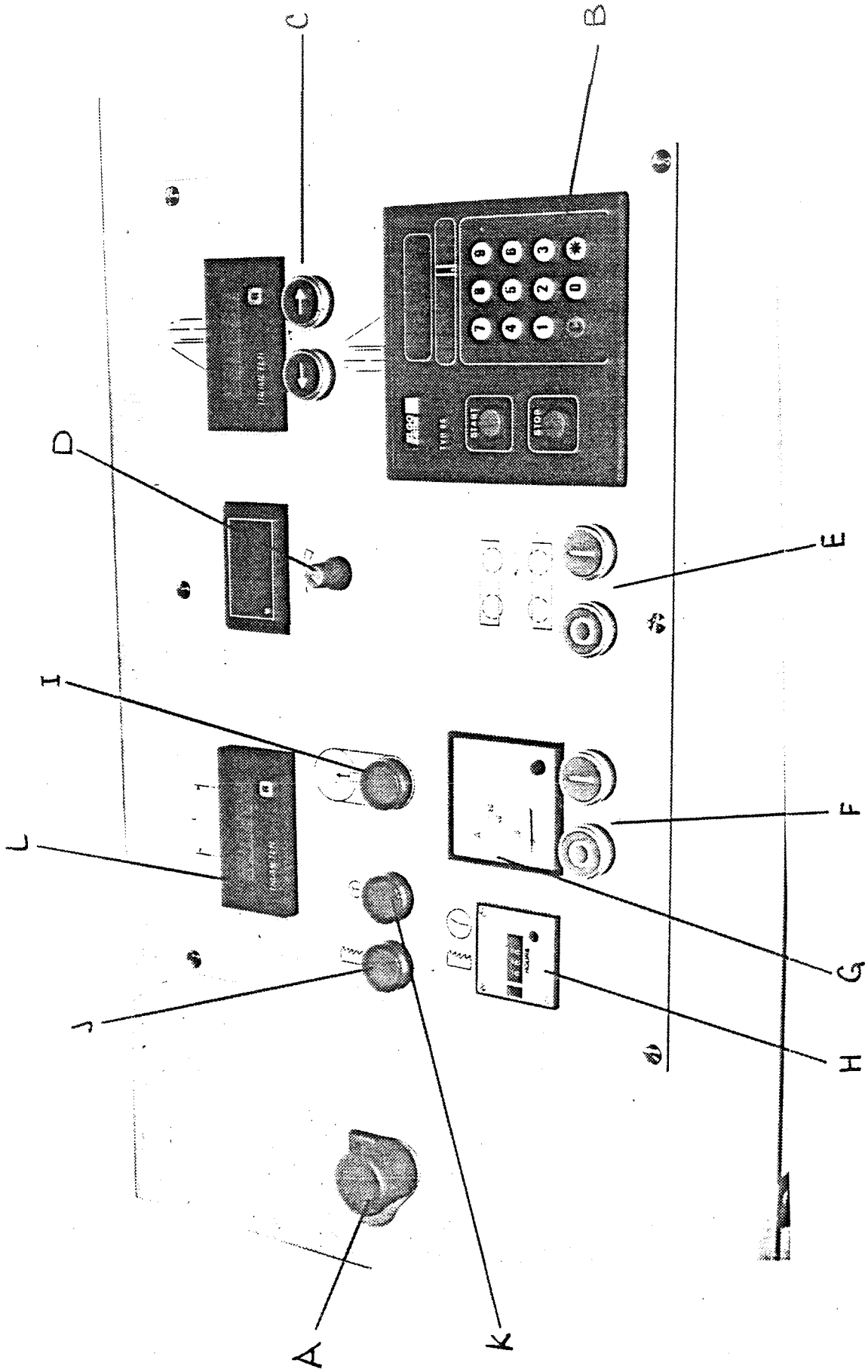

CONTROL PANEL

- A. Emergency Stop Button.
- B. Fence Positioner
- C. Feed Roll Positioner
- D. Feed Speed Control
- E. Feed Roll Start/Stop
- F. Main Saw Start/Stop
- G. Main Saw Ammeter
- H. Main Saw Running/Hour Indicator
- I. Saw Tension Pressure Indicator
- J. Saw Tracking Indicator
- K. Saw Change/Operator Jog Indicator
- L. Timber Length Counter

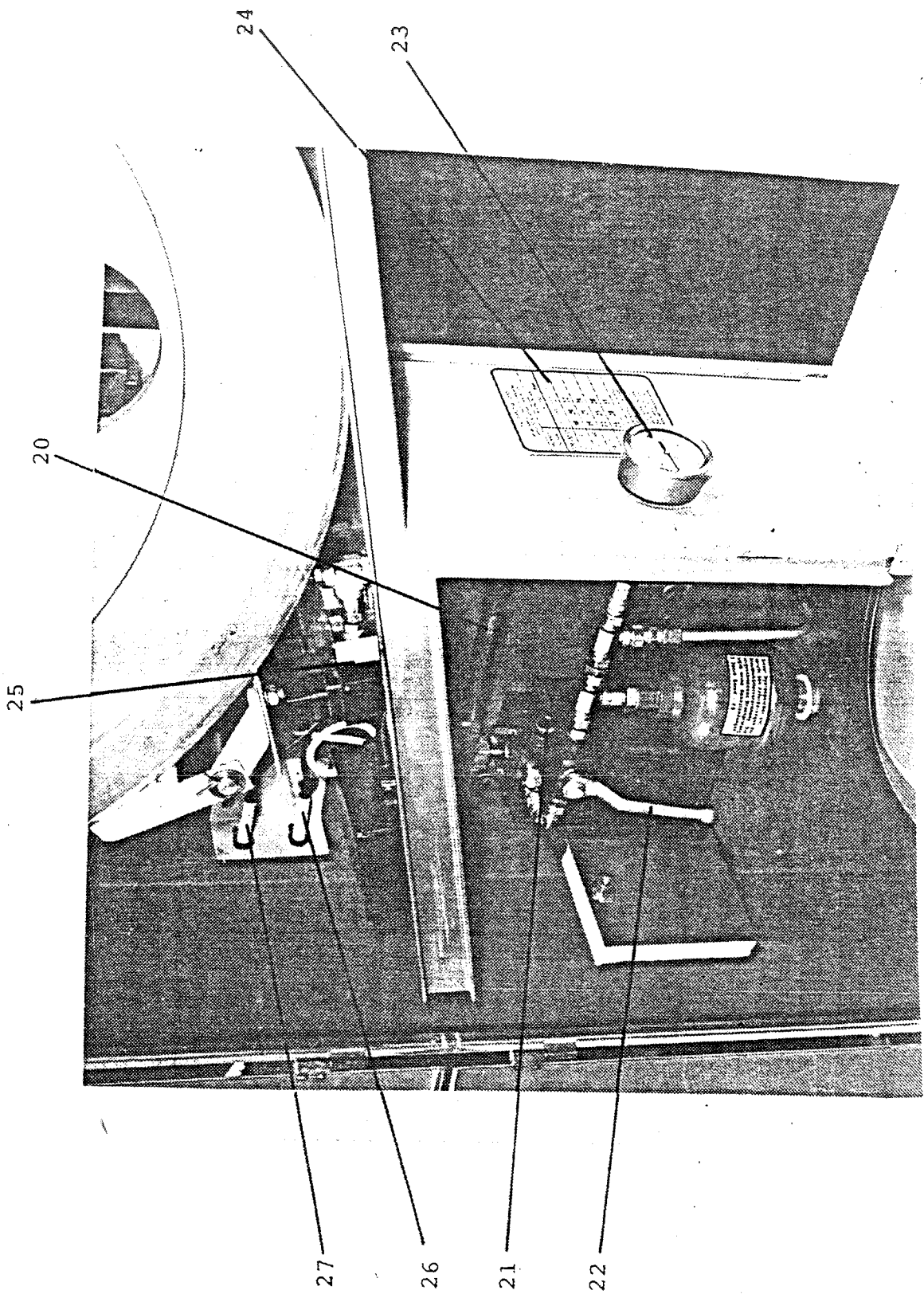

GENERAL INSTRUCTIONS ON MACHINE OPERATION

Various safety devices have been installed in the machine to increase the operators awareness of the tensioning and tracking of the saw blade.

1) Positioning the Saw

- i. Switch the isolator to the 'on' position
- i.i. Release the master stop button. All readouts on the control panel should now be lit with the exception of the tension, tracking and operator jog indicators.
- iii In order to position the saw and ensure the machine is not started inadvertently, the two position switch (19) on the pillar should be turned to position 2 this isolates the panel but allows the main motor to be jogged when required.
- iv The Saw Blade can now be positioned over the top and bottom Saw Wheels with the toothed edge of the saw overhanging approx. 3mm beyond the base of the gullets.
- v Tension top Saw Wheel by operating handle on tensioning pump (20) ensure the release handwheel (21) is locked by turning clockwise and the stop valve (22) is in the open position operate handle until desired pressure is reached on gauge (23). Check with tensioning pressure plate (24) re saw width and gauge (i.e. 127 wide, 20S gauge saw (24 BAR) on reaching pressure close stop valve (22) and recheck pressure.

NOTE. To release tension reverse above procedure.

If a slight reduction is required this can be carried out by careful control of Handwheel (21).

The pressure switch (25) in circuit will now have been operated allowing power to jog the main motor. Indicator (I) will be illuminated on the panel. The initial tracking proximity switch (26) will now be energised

by the tip of the saw blade when the saw is running this will indicate that the saw is tracking correctly and indicator (J) will be illuminated on the panel.

The second proximity switch (27) is an indication of saw position, if the saw moves forward the operation of the switch cuts power to the feed, also the saw tracking light (J) goes out on the panel thus indicating a tracking problem.

The saw should now be run up and the manual tracking handwheel (28) adjusted to track the blade correctly.

Push jog button (29) until sufficient speed is attained and adjust handwheel (28) as necessary. Releasing the button cuts power to the motor.

Once the saw is tracking correctly the two position switch (19) should be returned to position 1 thus energising the panel once more.

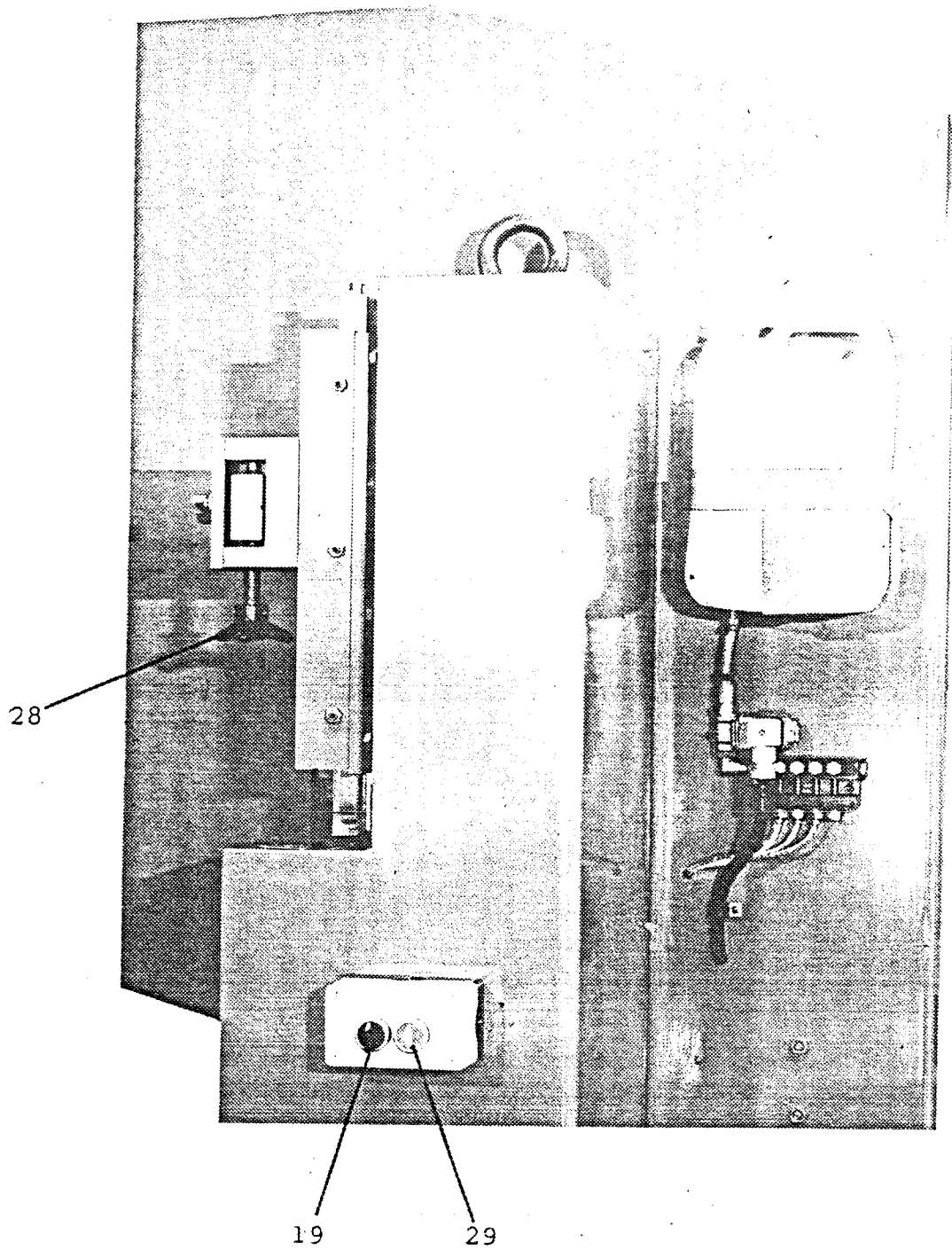

SETTING THE FENCE ROLL POSITION

The fence is positioned by the control unit (B) at the bottom right of the panel.

Set position required by operating the numbered buttons on the right of the unit.

The green push button initiates positioning sequence. The red pushbutton stops the positioning, should a problem occur, i.e. incorrect setting, obstruction, etc.

To change position push button (C) (on the unit), key in desired value and depress start button. If maximum position is reached and fence unit stops, depress the RED stop button before resetting dimension.

NOTE: If * LED is illuminated positioning is inhibited, press * button to clear.

SETTING THE FEED ROLLS

The feed rolls are set by the two pushbuttons (C) in the top right of the panel. Arrows on the buttons indicating direction.

The unit moves as long as the button is depressed. The readout above the buttons show actual position of the rolls therefore an amount for driving pressure has to be allowed. Recommended value being 10mm less than timber width between saw and feed rolls. The feed rolls are provided with a spring pressure unit, maximum allowable movement from a dead setting 20mm.

NOTE

The maximum movement of fence rolls and feed rolls is 275mm. If values above this are chosen they will move out to maximum and stop. A check should be made on value required and position reset accordingly. The fence and feed roll positions can only be adjusted when the feed rolls are not running.

FEED SPEED INDICATION

This is controlled by the knob (D) and indicated by the readout above it at the top centre of the panel. Turning the knob clockwise increases the feedspeed. The feed speed can be set without the feed running.

FEED START

The two pushbuttons (E) bottom centre of the panel start and stop the feed rolls. The rolls will only start when the main tracking has been run up to speed and the tracking proximity switches are set correctly.

SAW RUNNING HOUR COUNTER (H)

Indicates number of hours saw has been running and can be used as an indication for changing the saw.

To reset counter depress rectangular knob at left of counter.

SAW TENSION PRESSURE INDICATOR (I)

When illuminated shows a minimum tension pressure for the saw blade has been achieved. Any setting below this minimum will inhibit the running of the main saw and feed motors. Should this lamp not be illuminated check saw tension.

SAW TRACKING INDICATOR (J)

Illuminated when saw blade is tracking correctly. If this light goes out check saw blade re-tracking.

SAW CHANGE/OPERATOR JOB (K)

When red lamp is illuminated the panel is de-energise (and the machine is being worked upon i.e. changing saw or checking machine) giving a measure of safety for changing the saw or maintenance to be done on the machine.

LENGTH INDICATOR (L)

Counts total length of timber through machine in running metres.

Indicator rest by depressing R. button on readout.

SAW GUIDES

Can be set as a pressure guide or as standard side guides, depending on requirements.

TOP AND BOTTOM PRESSURE GUIDE SETTING

Remove top outer guide block from contact with saw. Position saw and tension with the carrier (30/31) in the back position (check that the guide is touching the saw blade, if not adjust accordingly).

Set square face of guide block (32/33) to touch sawblade. Fix in position with nuts (34 and screws 35.) Loosen locking nut/screw (36/37). Move horizontal pointer (in eccentric) (38) half a turn clockwise. This moves the carrier guide and sawblades 3mm thus applying guide pressure.

Lock nut/screw (36/37) in position.

STANDARD SIDE GUIDE SETTING

TOP OUTER GUIDE

Position saw and tension

Ensure carriers are in back position

Loosen screws securing guide blocks 34/35

Push guide up to saw and set approx. 0.005", 0.12mm from saw.

This is achieved by placing a piece of paper between the saw and guide block. Adjust guide until the paper is gripped gently against the saw. Tighten guide block screws.

Remove Paper.

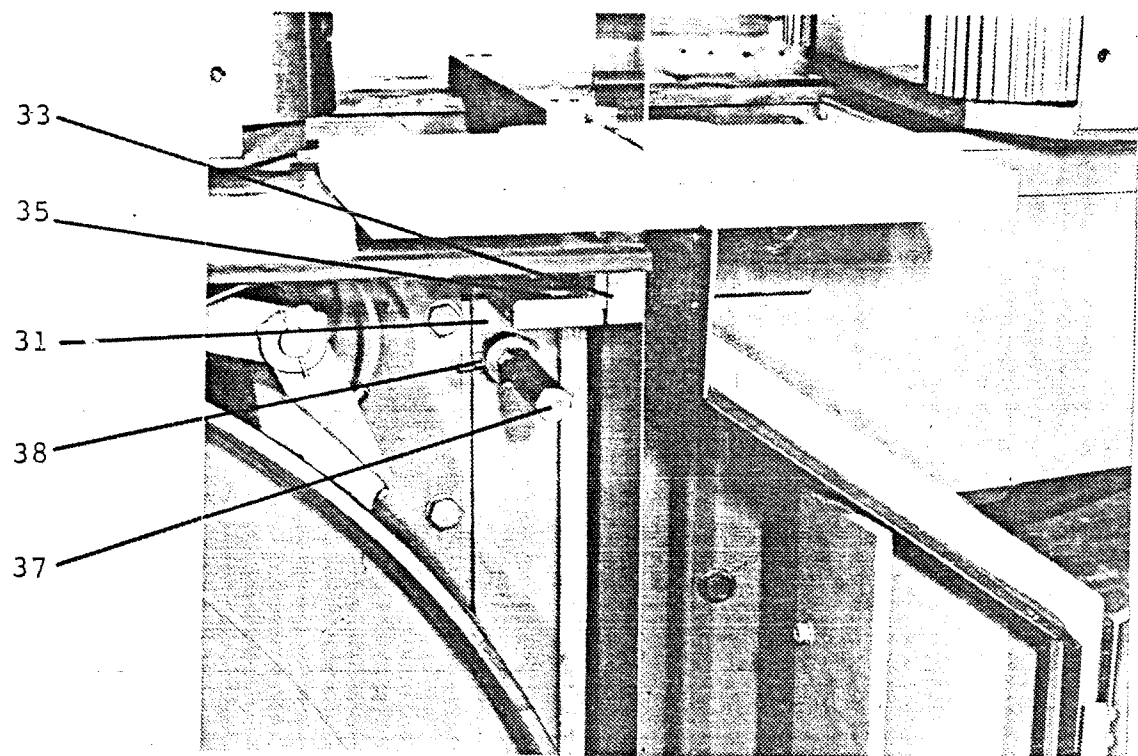
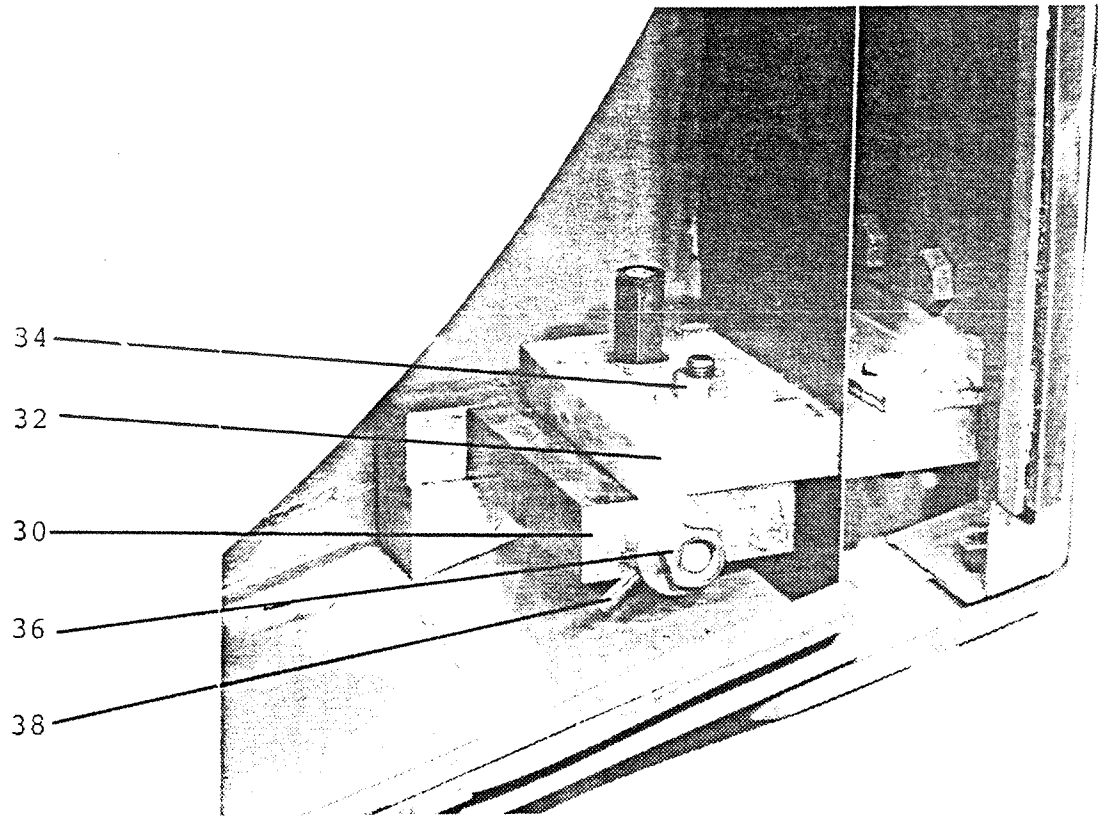

SAW LUBRICATION AND CLEANING

Scrapers and pads are provided for cleaning each saw wheel and a pad for cleaning the inside of the saw all pads are supplied with a cleaning lubricant from a central reservoir.

Individually adjustable (pre-set) drip points control the fluid flow and a solenoid valve (39) immediately below the reservoir (40) allows the supply to the distributor (41) when the machine is switched on.

To refill the reservoir push the red collet up on the connector (42) under the reservoir and remove pipe.

Lift reservoir from bracket and fill to desired level. Reservoir capacity 5 litres return reservoir to bracket reconnect pipe pulling collet into position.

MAIN SAW WHEEL DRIVE

Adjustment and tensioning is by screwed rod (43) at rear of main frame.

The drive belts are Brammer Link Belts. The tension should be sufficient to prevent the belts slipping.

As a guide, loosen the tensioning nut and let the weight of the motor be taken on the drive belts apply slight tension by hand to ensure the belts bed into the grooves. Lock rear nut in position locate and lock front nut in position on tension screw.

INITIAL ASSEMBLY/REPLACEMENT OF MAIN DRIVE BELTS

Check all belts are the same length.

Thread each belt in turn around the main saw wheel drive pulley and motor pulley with motor pulled back against the main frame.

Position belt over groove on saw wheel pulley, fasten belt at motor pulley and squeeze belt over into motor pulley groove. To fasten belt snap last link over stud heads and turn 90 deg. with tool supplied.

Working alternatively from motor pulley to saw wheel pulley move the

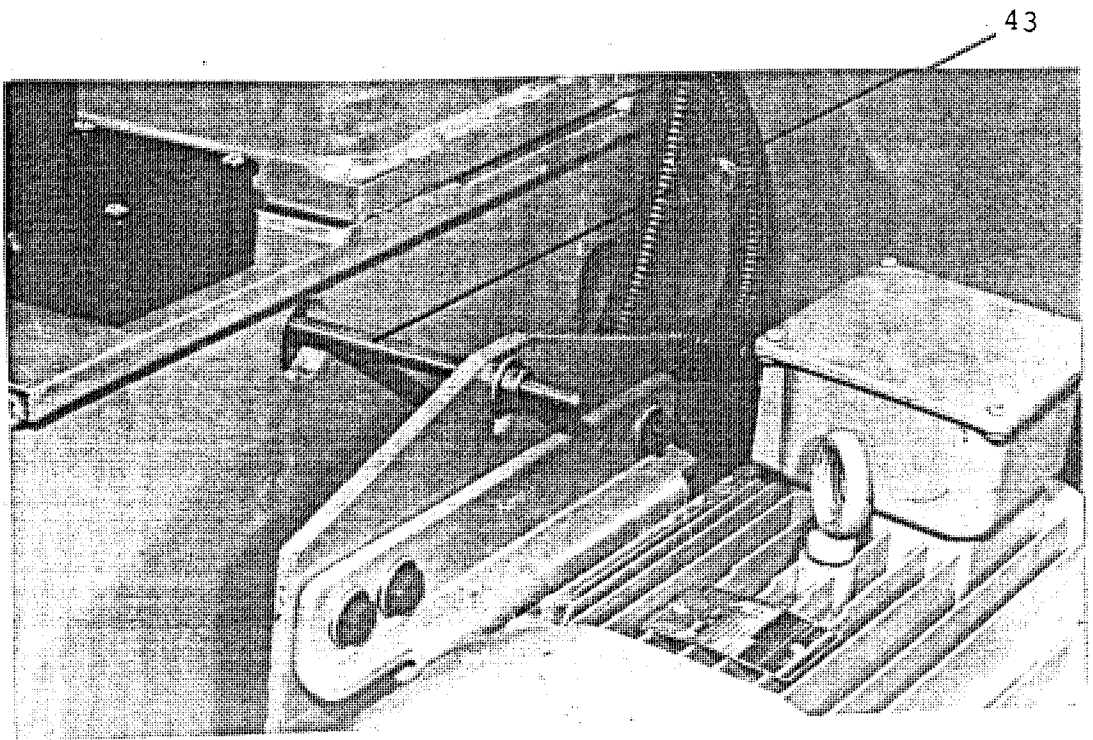
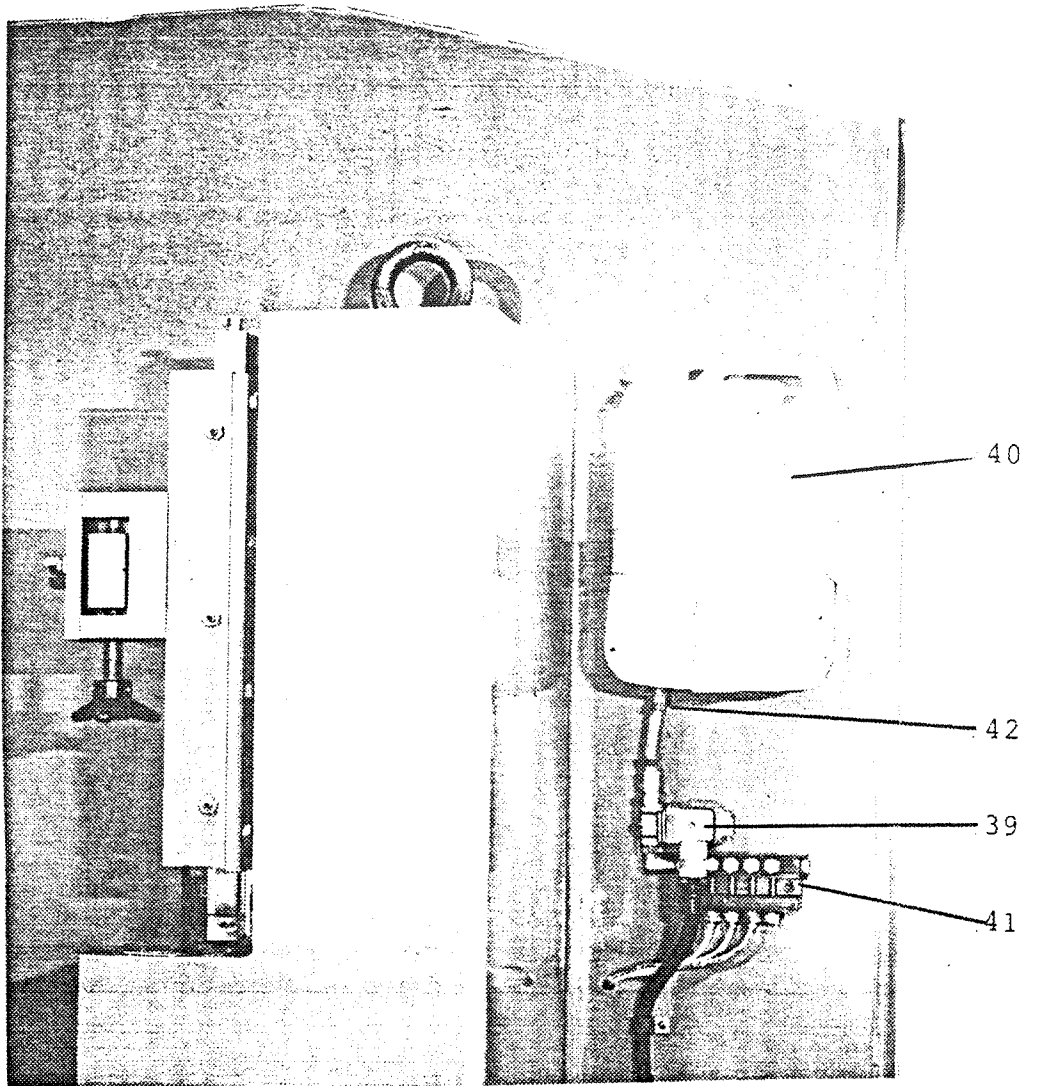

belt through each groove, until belt is in groove furthest from motor. Repeat above procedure until all belts have been assembled then tension drive following procedure above.

GENERAL MAINTENANCE

BEARINGS

TOP AND BOTTOM SAW WHEELS.

Every 500 hours replenish with 4cc of Mobilux 2 grease (equal to 10 strokes per nipple of grease gun supplied).

FEED ROLL BEARINGS:- Are the sealed for life type and need no attention

MOTOR BEARINGS:- Are grease packed during assembly with a measured amount sufficient for two years continuous operation without attention under normal conditions.

A Lithium based grease which contains oxidation and corrosion inhibitors is used.

SLIDES

TOP SAW WHEEL

Oil cups are provided at the top of each slide fill monthly with a standard lubricating oil.

FEED BED

Clean once a week to remove sawdust.

SAW TENSIONING SYSTEM

This is a closed system and should only require checking once a year.

Top up as required with hydraulic oil type Apollo 32 or equivalent.

Mobil DTE 24.

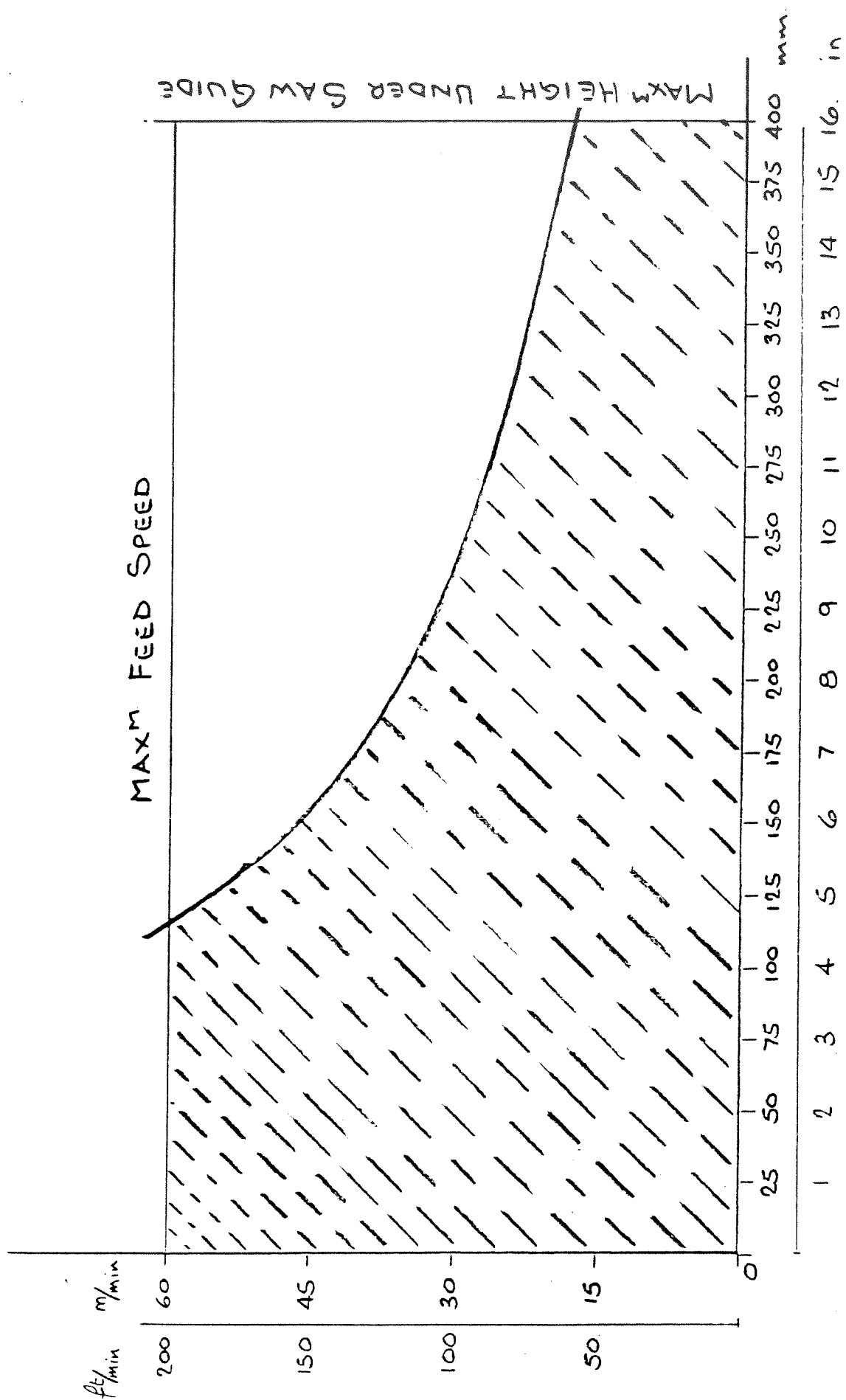

GUIDE TO FEED SPEED WHEN CUTTING A SPECIFIC TIMBER DEPTH

Due to the many other factors involved the graph can only be used as a general guide for the initial setting of the Feed Speed.

If the reading on the main motor ammeter (G) exceeds 33 amp then the feed speed will have to be reduced proportionately otherwise the motor will overheat and eventually burn out.

Conversely if the reading is low then if conditions allow, the feed speed may be increased accordingly.

Below is a list of spares for the machine.

Should information and/or spares be required please quote machine type and test number, both of which can be found on the machine plate fastened to the pillar.

1 - FS 8100	SKF 22310C	TOP SPINDLE
1 -	1310	" "
2 - FS 8272	SKF 22212C	BOTTOM SPINDLE
20231	SKF 6006-2RS	FEED/FENCE ROLLS
FS 6498	35 BORE OILITE BUSH	INFEED ROLLS
5 - Fs 11285	BRAMMER 'B' SECTION	MAIN DRIVE
	83 LINKS	
1 - FS 4591	FELT PAD	SAW WHEEL
1 - FS 4591	FELT PAD	SAW
2 - FS 5492	SCRAPER	SAW WHEEL
2 - ES/11/100	SAWGUIDE PAD	TOP
1 - ES/11/106	" "	BOTTOM INSIDE
1 - ES/11/107	" "	BOTTOM OUTSIDE
5/8" PITCH CHAIN	110056	FEED DRIVE

MACHINE LIFTING POINTS:

3 - Lifting Points have been provided on the machine consisting of two retractable pins on the left of the mainframe and on top of the pillar.

Care should be taken to balance the lifting slings to ensure an even lift.

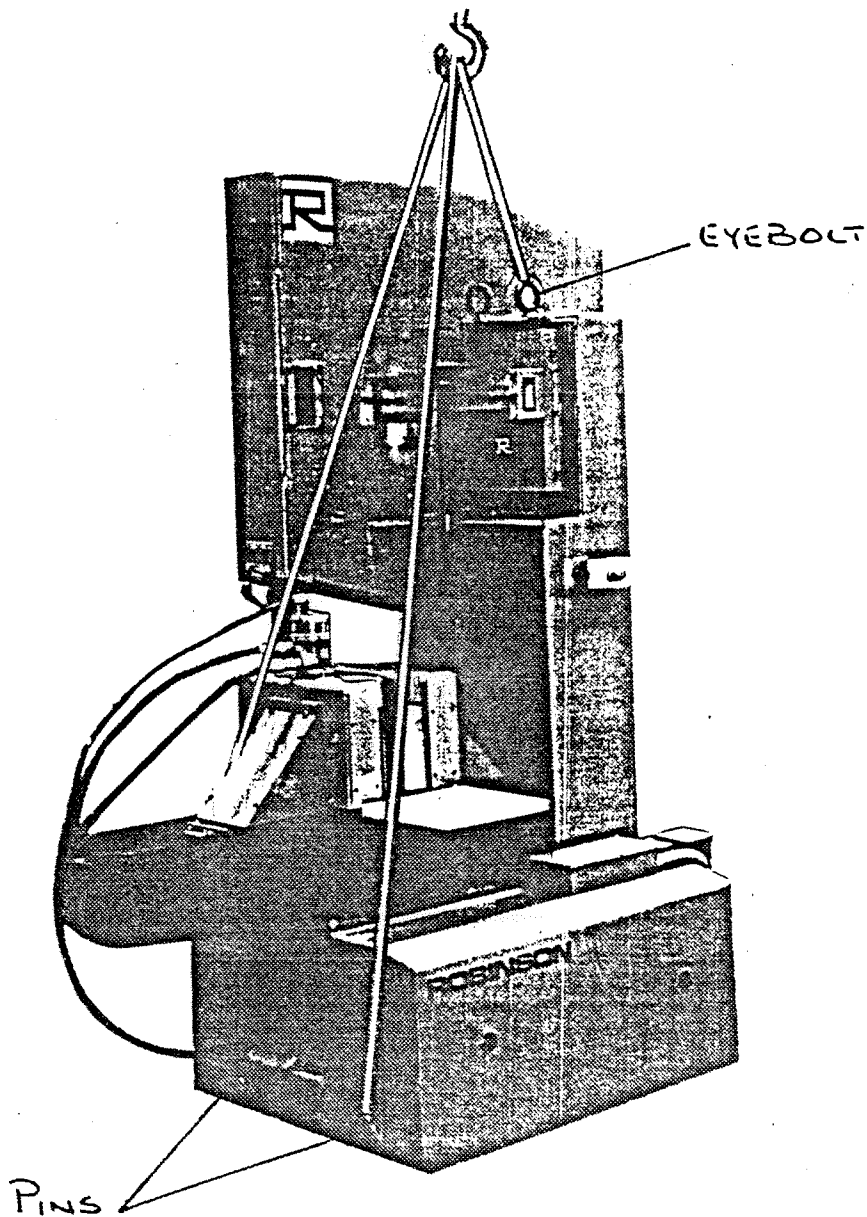

ASSEMBLY OF BOTTOM SAW WHEEL

With machine mounted on prepared base the bottom saw wheel can be positioned in the machine as follows.

Taking care lift the saw wheel into the upright position.

Using a fork lift truck position either one or two holes in the saw wheel.

On the forks of the truck approx. 100mm from end of forks, with slight tilt on forks, lift saw wheel off floor. Drive truck towards machine until saw wheel just lines up with inside of pit. Lower saw wheel to align shaft with hole ensuring keyway is at the top. Guide shaft in hole at the same time as driving the truck forward slowly. Once the shaft is engaged push in for approx. 100mm. The saw wheel should now hold. Remove forks from holes and gently push saw wheel back to locate against the shoulder on the shaft. Ensuring scraper and pad are over the saw wheel.

Position spring on scraper and pad brackets from the front of the machine. Check on alignment of keyway with locating peg(1).

Position keyway until located in peg tighten locknut.

Locate locking screw (2) and tighten.

Check saw wheels for free rotation.

The main drive belts should now be assembled. See Page 18, Initial Assembly of Main Drive Belts.

Choose from 4 models - designed for high volume production

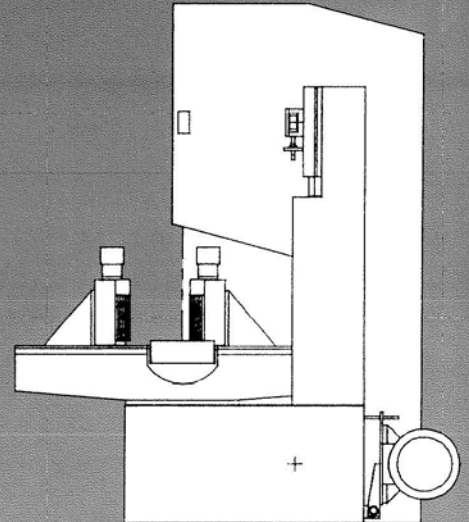
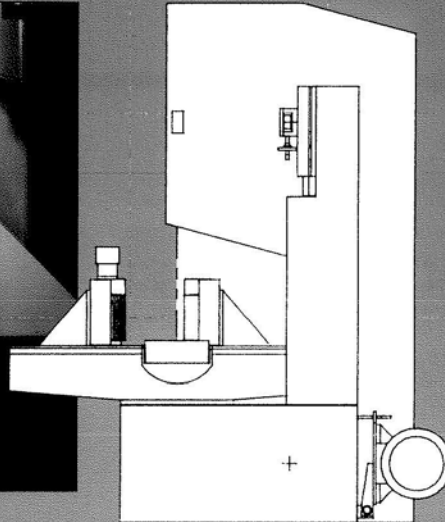
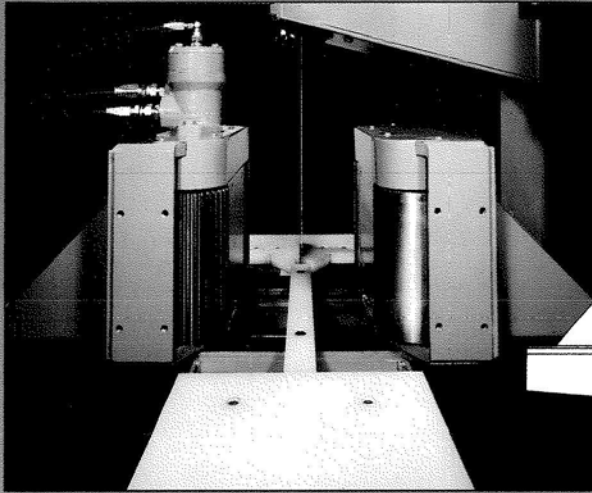

Two banks of feed units each carrying two 130mm dia x 200mm deep rollers.

ES1 - Hydraulically driven feed; idle roller fence

ES2 - Hydraulically driven feed and fence rollers

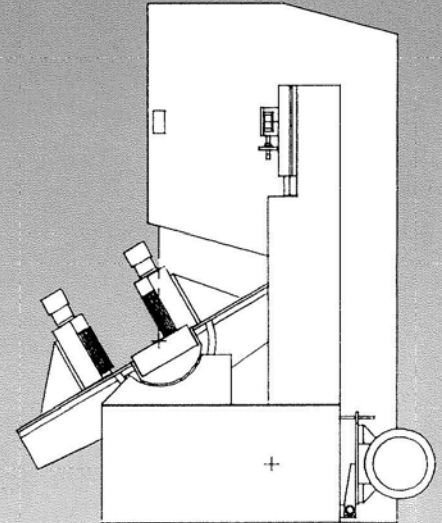
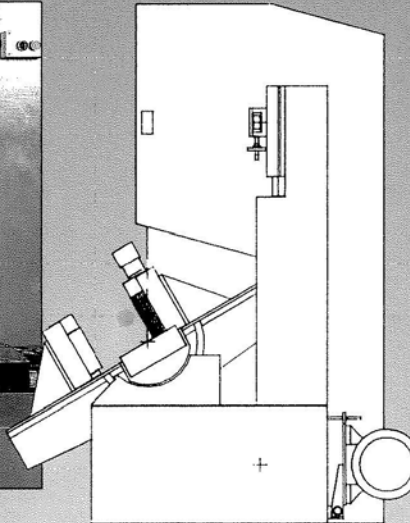
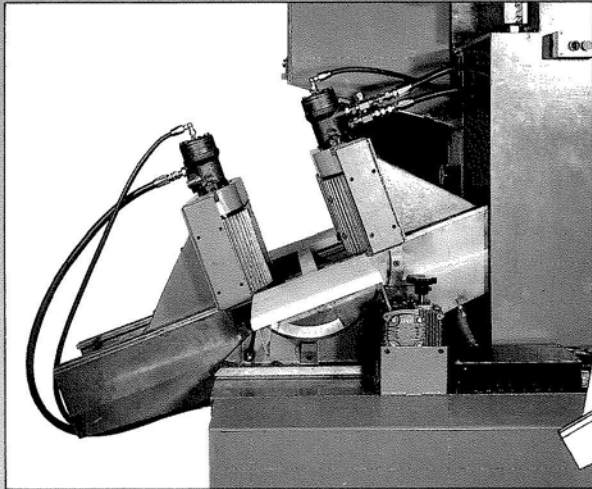

Table cant of up to 45° available on ES3 and ES4 models

ES3 - Arranged as ES1 with canting table

ES4 - Arranged as ES2 with canting table

ES1000 SPECIFICATION

Working height	800mm
Wheel diameter	1000mm
Saw blade width	100mm min. 127mm max
Feed speed	0-60 m/min.
Feed roller diameter	130mm
Fence roller diameter	130mm
Feed and fence roller depth	200mm

Feed and fence roller centres	300mm
Feed roller centre to saw	40mm
Max. distance saw to feed roller	275mm
Max. distance saw to fence	275mm
Max. distance under saw guide	400mm
Main drive motor	18.5kW (25hp) Std. 22kW (30hp) Optional

As our policy is to constantly improve design, the details given in the leaflet are not to be regarded as binding.



Wadkin Leicester
Green Lane Works, Leicester LE5 4PF, England.

Telephone: 0116 2769111 www.wadkinburgreen.co.uk

A Division of Wadkin plc Member of The Thomas Robinson Group plc
Designed by McConnell's (Midlands) Ltd.

Leaflet No. 1454/4321
Printed in England.