

Wadkin

30" PANEL PLANING AND THICKNESSING MACHINE TYPE R. J.

PRINCIPAL DIMENSIONS AND CAPACITIES :

Planing and Thicknessing Capacity.....	30" x 9"
Speed of Cutterblock in r. p. m.....	4500
Diameter of Cutting Circle.....	5"
Diameter of all Feed Rollers	5"
Width of Sectional Feed Roller Sections	2"
Width of Sectional Chipbreaker Sections	2"
Length of Table	3'9"
Standard rates of Feed in feet per min	25, 37, 57
Horsepower of Cutterblock Motor	15
Horsepower of Feed Motor	2
Floor space	4'-3" x 6'-4" wide
Nett weight	40 cwts. (4480 lbs.)

Details included with the machine :

One set of High Speed Steel Cutters.

One Chip Deflector or Dust Hood.

Cutter Setting and Jointing Device.

One set of Spanners.

One Lubricating Pump and tin of special Ball Bearing Lubricant.

T: 0116 2769111

Wadkin OPERATING AND MAINTENANCE INSTRUCTIONS

GENERAL VIEW OF 30" PANEL PLANING AND THICKNESSING MACHINE, TYPE R. J.

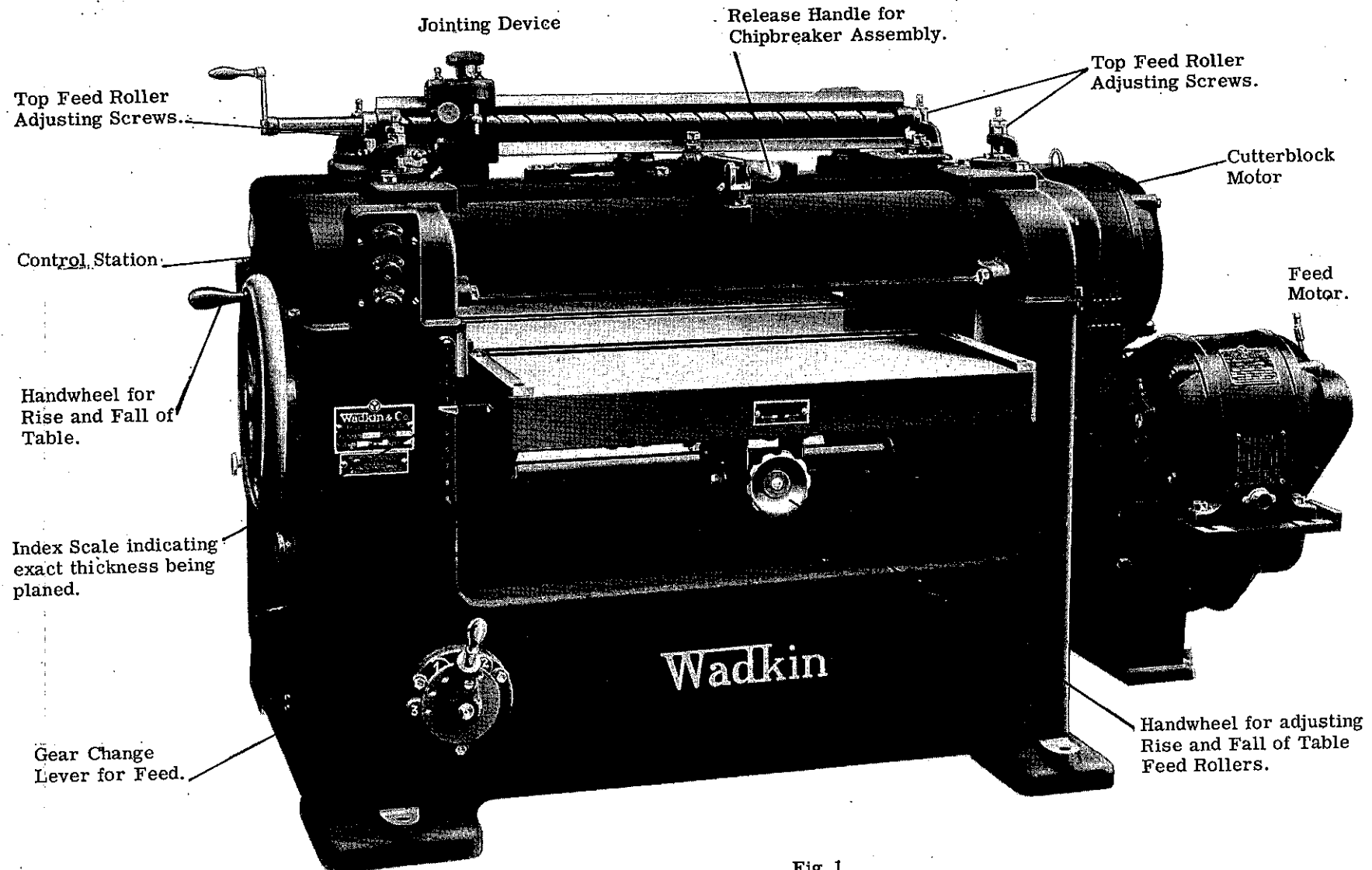

Fig. 1

INSTALLATION.

The machines are despatched from the Works with all bright surfaces greased to prevent rusting. This must be removed by applying a cloth damped in paraffin or turpentine to the greased parts.

FOUNDATIONS.

5/8" (16) diameter foundation bolts should be used to bolt the machine down to the floor. If the Mill floor consists of 6" (150) solid concrete, no special foundation is required. Rag type foundation bolts may be used in the position shown on the foundation plan. 4" (100) to 6" (150) square holes should be cut in the concrete for these bolts after the machine has been carefully levelled and a 3/4" (20) thick packing placed under the gearbox foot. It should be grouted in with liquid cement.

ELECTRICAL INSTALLATION.

See pages 14 & 15 for full instructions for electrical installation and maintenance.

DUST EXTRACTION.

A chip deflector is normally supplied, but if the machine will be connected to a main dust exhaust plant a dust hood will be provided in lieu of deflector.

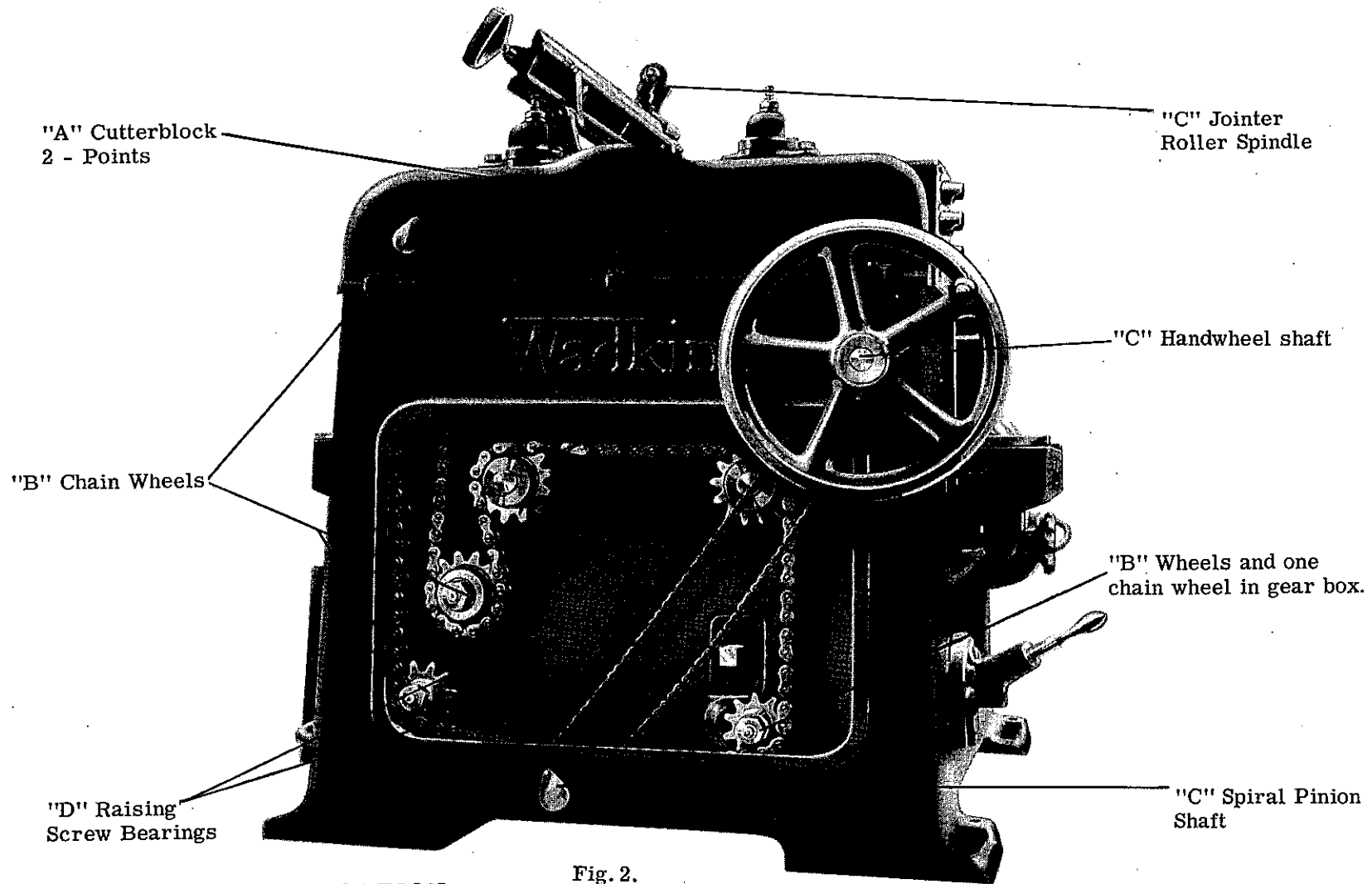

Fig. 2.

LUBRICATION

- Points "A" Ball bearings give 4 to 6 charges of grease gun every 3 months
- Points "B" Give one charge of grease gun daily
- Points "C" Give one charge of grease gun weekly
- Points "D" Give one turn of grease cap weekly

Use Wadkin grease, Grade L. 6.
For equivalent lubricants see page 10.

Oil all chains and raising screws weekly.

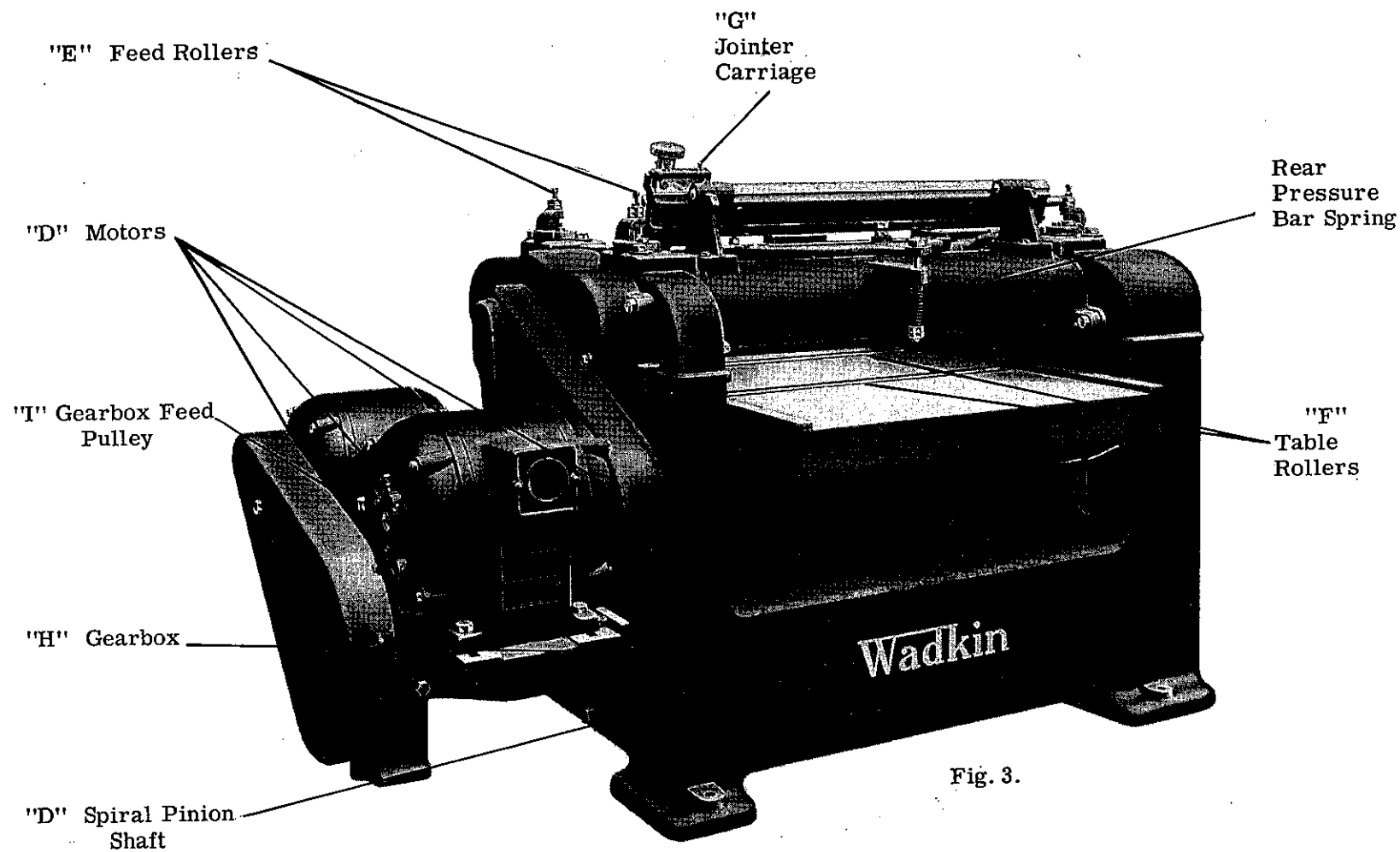

Fig. 3.

LUBRICATION

Points "E" oil daily
 Points "F" fill oil reservoir weekly
 Points "G" oil weekly

Points "H" drain old oil and refill every 4 months
 using gear oil, Wadkin Grade L. 2.
 Points "I" give one turn of grease cap daily

The sectional feed rollers are grease lubricated on assembly.
 NOTE: Use Wadkin grease Grade L. 6 and oil, Grade L. 4.

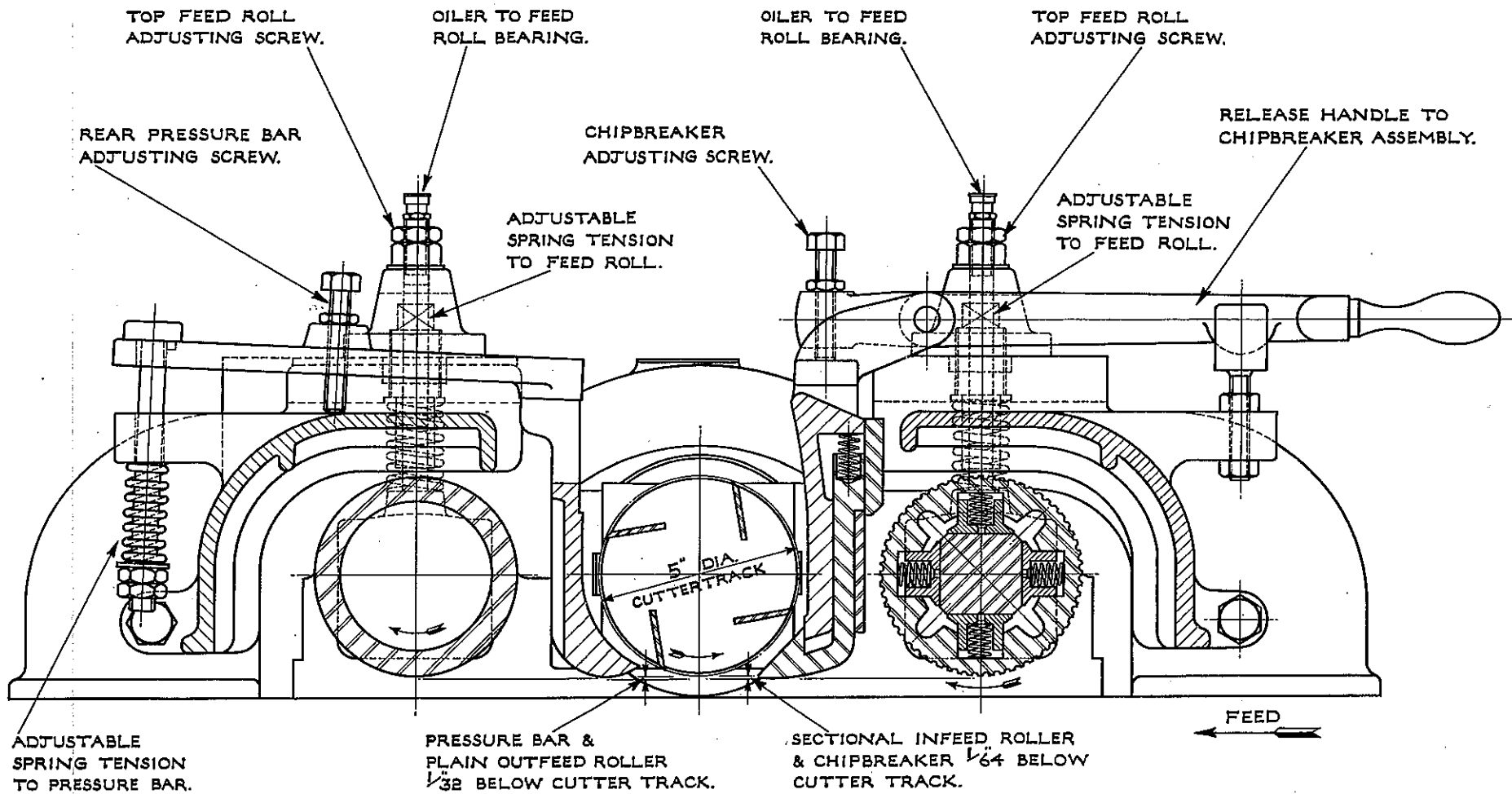

ADJUSTMENT OF FEED ROLLERS AND TOP PRESSURES.

THE CUTTERS

For general work knife angles for soft and hard woods are recommended as in Figs. 5a and 5b. Where a very fine finish is required on dry soft and hard woods a slight front bevel should be given as in Figs. 5c and 5d. For wet or green timber the cutting bevel may be increased by 5 degrees, but the front bevel should not be given.

NOTE: The cutterblock is $4\frac{7}{8}$ " diameter, therefore cutters must project $1/16$ " from the body of the block when correctly set.

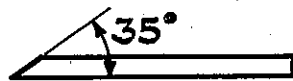

Fig. 5a for soft wood.

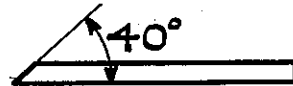

Fig. 5b for hard wood.

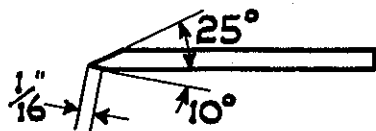

Fig. 5c for dry soft wood.

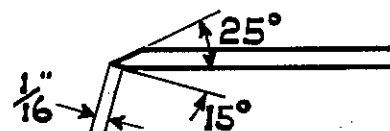

Fig. 5d for dry hard wood.

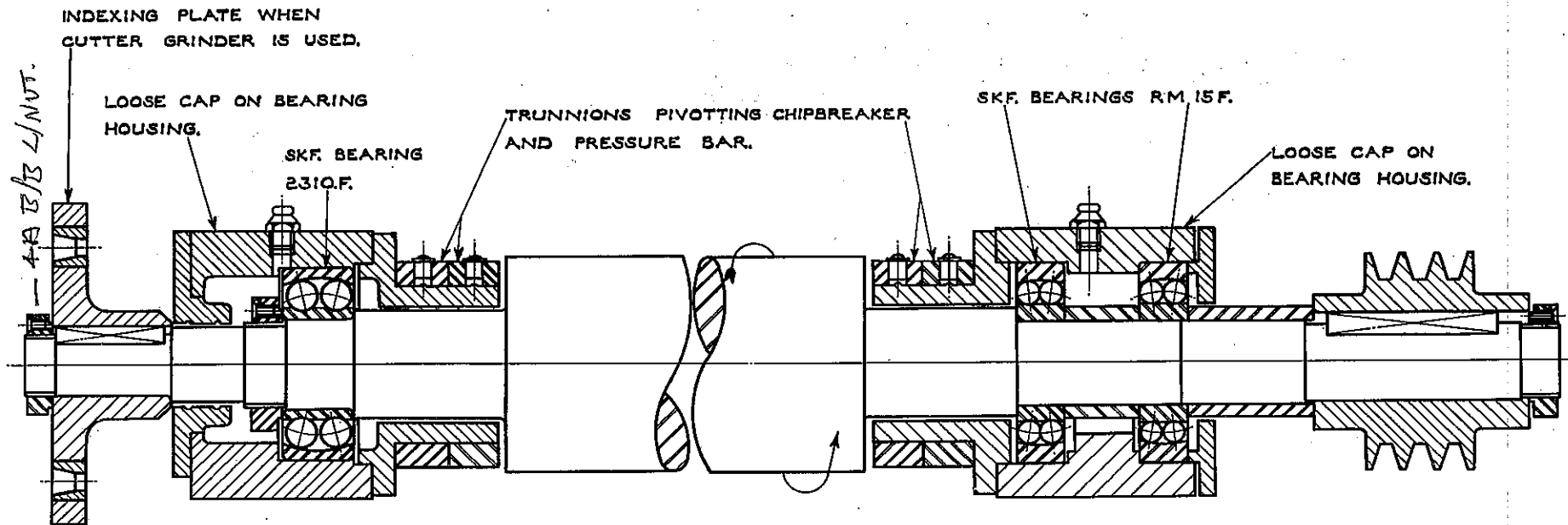
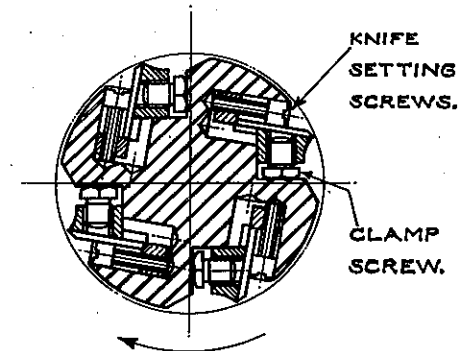

FIG. 5. ARRANGEMENT OF CUTTERBLOCK SPINDLE.

TABLE.

The large handwheel on illustration Fig. 1 operates the main rise and fall movement to the table. The index pointer attached to the infeed end of the table indicates on the scale the exact thickness of timber being planed. The maximum rise and fall of the table is 9". The small handwheel on Fig. 1 gives a vertical adjustment to the two feed rollers in the table thus enabling the rollers to be quickly set in relation to the table surface, to suit the condition of the timber.

FEED ROLLERS.

The feed rollers are all power driven. The top front feed roller is grooved and is of the sectional type,

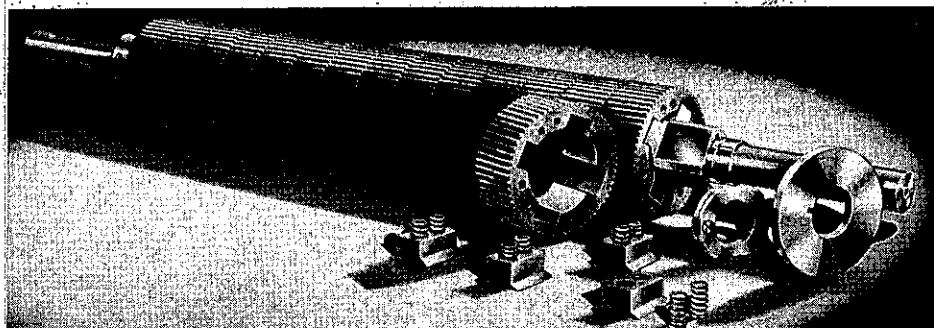

Fig. 6

SECTIONAL FEED ROLLER

as shown at Fig. 6. The sections are 2" wide and each section is controlled by 8 coil springs allowing for a 3/16" variation in timber thickness. The initial pressure on the top feed roller is obtained by adjusting the screws in Fig. 5.

CHIPBREAKER.

The chipbreaker in front of the cutterblock is also of the sectional type as shown at Fig. 7. The lever in Fig. 5 enables the operator to raise the entire chipbreaker assembly for convenience in cleaning the section faces.

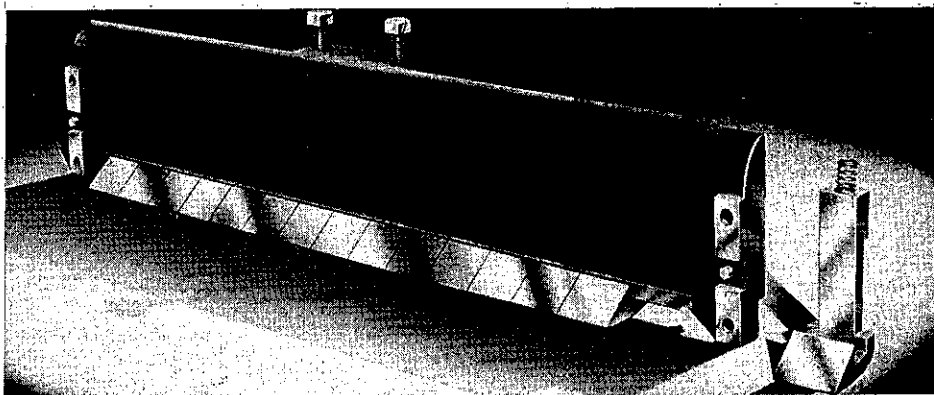

Fig. 7

SECTIONAL CHIPBREAKER

BACK PRESSURE BAR.

The back pressure bar is carried concentrically with the cutterblock and the pressure is controlled by one central spring. This spring is carried on a stud as shown at Fig. 5. Adjustment is obtained with two locknuts.

CUTTER SETTING AND JOINTING DEVICE.

In order to ensure that all the knives in the cutterblock of the Planing Machine are all actually cutting and each doing its share of work per revolution of the spindle, it is essential they all run in one common circle of the same diameter at the cutting edge. To give the operator the desired means of obtaining the accuracy required the 30" Planing Machine R. J. is fitted with a combined Knife Setting and Jointing Device as shown at Fig. 8. In operating this device it is essential the knives are first set to one common diameter by using the hardened steel roller marked 'J' Fig. 8. This roller must fit accurately into its socket and be securely locked with handle 'K'. The cutter is brought outwards from the main cutter-

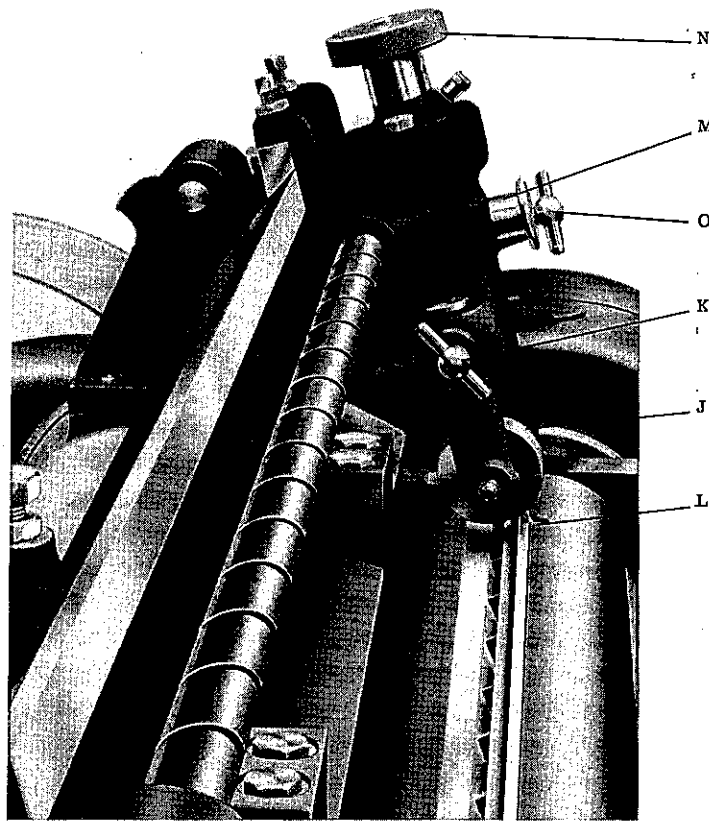

Fig. 8. KNIFE SETTING AND JOINTING DEVICE

block by means of the special key inserted at 'L', until the cutter comes lightly into contact with the underside of the roller. The roller itself should locate the knife at 3 points along its length to obtain the correct setting, after which all the cutter locking screws should be securely tightened. The clamping wedges in the block must hold the knife sufficiently rigid while it is moved by the key. The remaining knives are all set in a similar manner. In order to traverse the setting wheel rapidly across the slide it is necessary to disengage the plunger 'M' Fig. 8.

When the setting operation has been completed the setting roller is turned clear of the cutterblock and locked in position with the handle 'K'. After each knife is set it is necessary to joint or true up all the cutting edges to a fine degree of accuracy. In using the truing device the plunger 'M' must first be engaged with the long spiral screw. The cutterblock is revolved at its normal speed and the device very slowly and evenly traversed from one end of the block to the other by means of the handle. The grinding stone which is controlled by the handwheel 'N' must be carefully adjusted until the stone touches the knives and gives off a very light spark. This operation is carried on very lightly until the knives appear to be in a true circle. It is essential and of the utmost importance that it should not be repeated unduly long, otherwise a double bevel is formed on the back of

Wadkin OPERATING AND MAINTENANCE INSTRUCTIONS

the knives. If this back bevel is too pronounced it is liable to rub on the work and thus give inferior planing. It is important that the jointing of the knives be carried out very carefully as a double bevel more than a 1/32" in length would be detrimental where smooth planing is required. Therefore if the bevel is beyond this amount then the complete set of knives must be removed from the cutterblock and reground. On completion of jointing the grinding stone should be withdrawn from the block and held in its top position with the tee locking handle 'O' Fig.8.

BALL BEARING LIST

Position on Machine	Makers No.	Quantity	Bore Dia.	Outside Dia.	Thickness
Cutterblock (non-drive end)	SKF. 2310F	1	50 M/M	110 M/M	40 M/M
Cutterblock (drive end)	SKF. RM15F	2	1.7/8"	4.1/2"	1.1/16"
Raising Screws	SKF Thrust Washer No. 0.8	2	1"	1.3/4"	5/8"

WADKIN RANGE OF OIL AND GREASE WITH EQUIVALENTS.

Wadkin Grade	EQUIVALENT LUBRICANTS		
	Shell-Mex and B. P. Ltd.	Vacuum Oil Co. Ltd.	Caltex Lubricants
Heavy Gear Oil Grade L. 2.	Shell Vitrea Oil 69	Gargoyle Oil D. T. E. /B. B.	Meropa Lubricant No. 2 Oil
Machine Oil Grade L. 4.	Shell Vitrea Oil 33	"Vactra" Oil (Heavy Medium)	Caltex Aleph Oil
Ball Bearing Grease L. 6.	Shell Nerita Grease 3	Gargoyle Grease B. R. B. 3.	Regal Starfak No. 2 Grease.

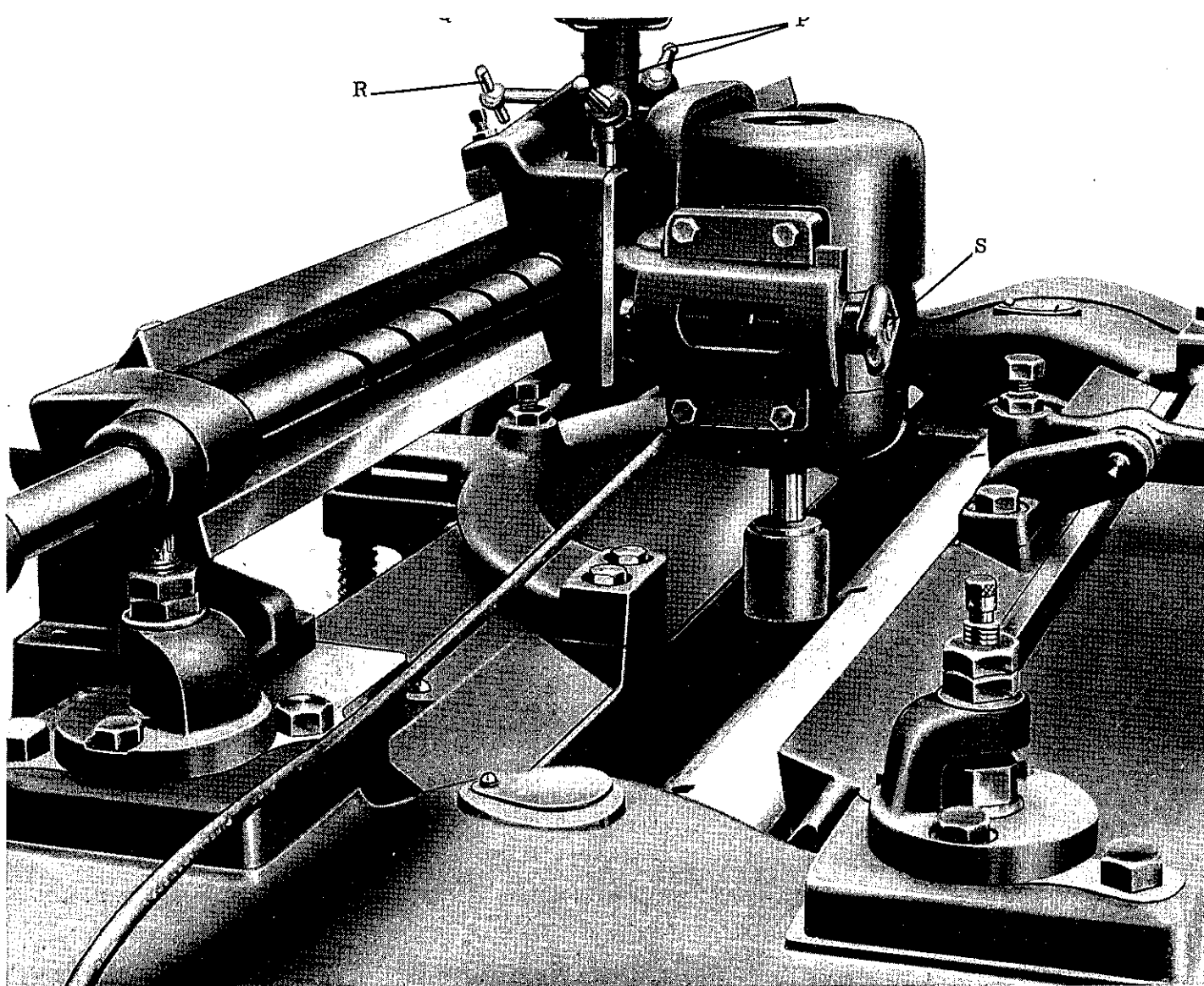

Fig. 9.

MOTORISED CUTTER GRINDER

When the cutters are not removed from the machine for re-grinding purposes a motorised grinding head fitted with a cup grinding wheel can be supplied as shown at Fig. 9. The motor unit fits on a slide bracket and the locking handles 'P' Fig. 9. clamp the unit in position on the traversing carriage. Vertical adjustment to the head is provided by the handwheel 'Q' and the tee handle 'R' locks the raising screw. Cross adjustment to the head is obtained by rotating handwheel 'S'.

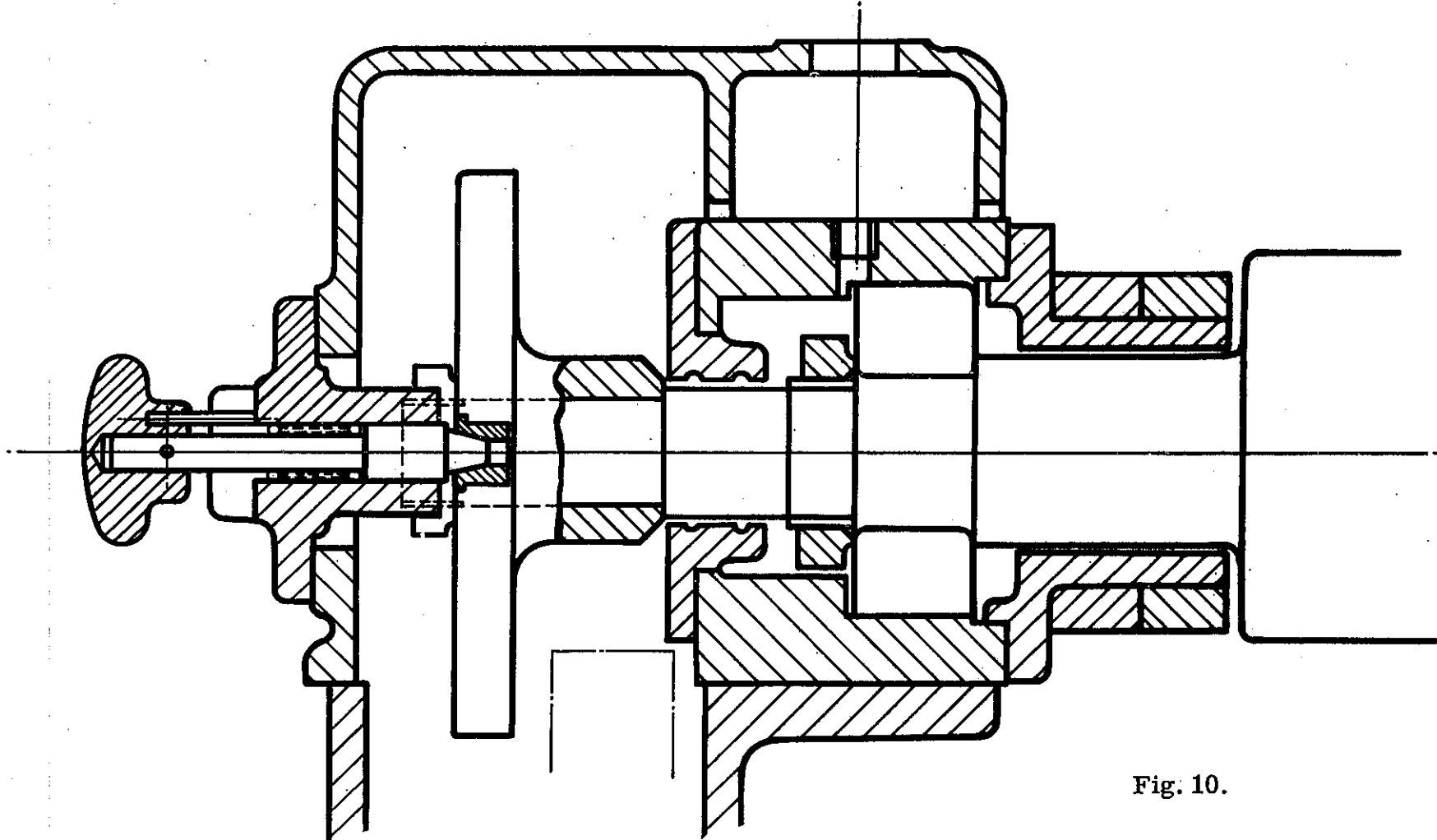

Fig. 10.

When this Grinding Head is used the cutterblock is indexed in four positions and the block is held rigidly in position with the spring loaded plunger shown at Fig. 10. The grinding wheel is traversed across the cutterblock by means of the handle, care being taken to give very light cuts until a flat bevel is obtained with a fine edge to the cutter. Each subsequent cutter is indexed to the top position, locked with the plunger and the grinding operation repeated. When re-grinding is finished on all the cutters it is essential to dis-engage the indexing plunger.

CUTTER SETTING AND JOINTING DEVICE.

(Machines fitted with motorised grinder only).

Fig. 11.

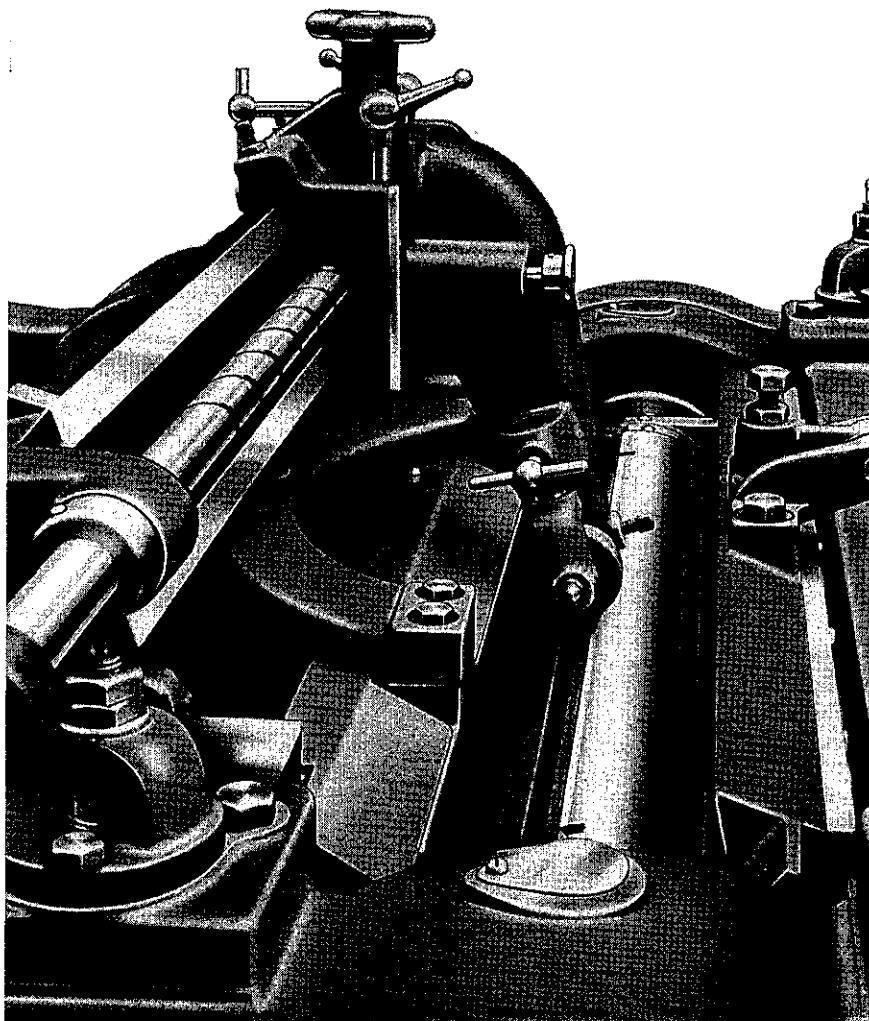

After re-grinding, the cutters must be tested with the Roller Setter and afterwards jointed. Remove the Grinder Slide from the main carriage by releasing the Locking Handles 'P' Fig. 9. and sliding the unit out of the Vee Slideways and fit the Combined Roller Setting and Jointing Bracket shown at Fig. 11.

The method of operating this attachment is the same as previously described on Page 9.

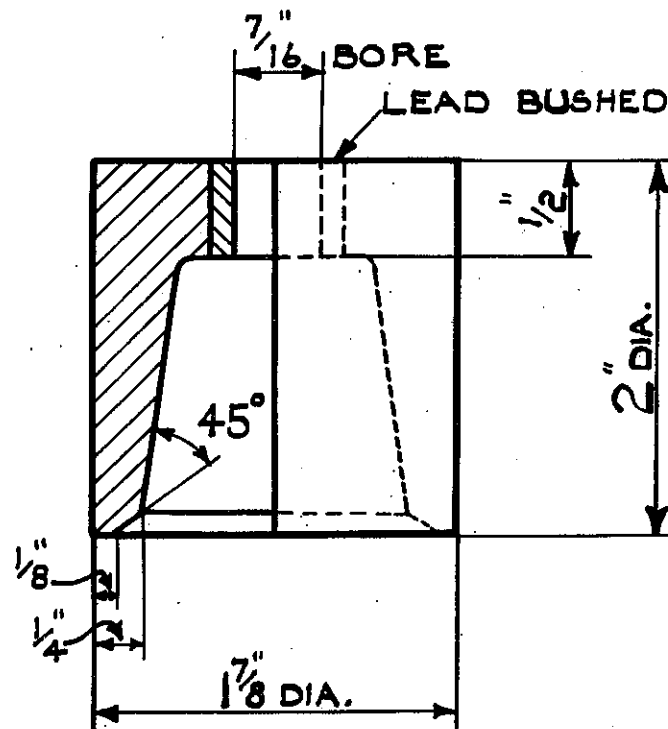

White Bauxilite Vitrified Cup Wheel
Ref. UGW. 152.

ELECTRICAL INSTRUCTIONS

INSTALLATION.

The whole of the cabling between the motors and the control gear is carried out by WADKIN LTD.

It is only necessary to bring line supply cables to the machine for it to be put into service. This should be done as follows :-

1. Fit triple pole isolating switch near machine.
2. Bring line supply cables to isolating switch and to L1-L2-L3 at contactor, see Dia. D203/1, through conduit which should be screwed into the machine and secured by means of locknuts.
3. Fill starter tank to indicated oil level with oil provided.
4. Connect the machine solidly to earth.
5. Ensure that the direction of rotation is correct before putting the machine into service, to reverse direction interchange L1 and L2 at contactor.

OPERATING INSTRUCTIONS.

To start machine :- Close isolating switch and press "start" cutterblock button, after allowing cutterblock motor to reach full speed the feed may be started by pressing "Start" feed button.

To stop machine press "Stop" button. To lock off machine press and turn "Stop" button.

NOTE:- This must be released before a start can be made.

ELECTRICAL INSTRUCTIONS (Continued)

MAINTENANCE

1. Change the switch oil twice a year. Use class B switch oil B. S. S. 148.
2. Change the fixed and moving contacts every two years. Do not file contacts. See Figs. 12 and 13
3. Blow motor down weekly with electric blower.
4. Check earth connection from time to time.

ADJUSTMENTS

1. **OVERLOAD** settings can be varied by means of adjustment pointers provided. This is normally done by Wadkin Ltd. , but if the setting is found to be too fine for the work normally done on the machine, the setting can be increased.
2. **TIMING DEVICE** on saw starter. To reduce the time of change over from the star to delta, screw down the red knob at starter.

GENERAL.

Users are recommended to display in an appropriate position in maintenance department, Wadkin Electrical Maintenance Instruction Card No. 356, which is issued gratis on application.

CONTACTS

Showing method of removal

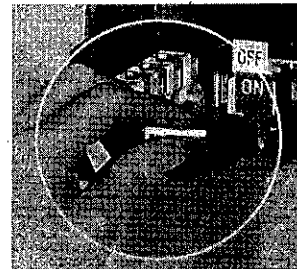

Fig. 12

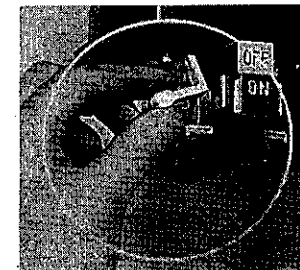
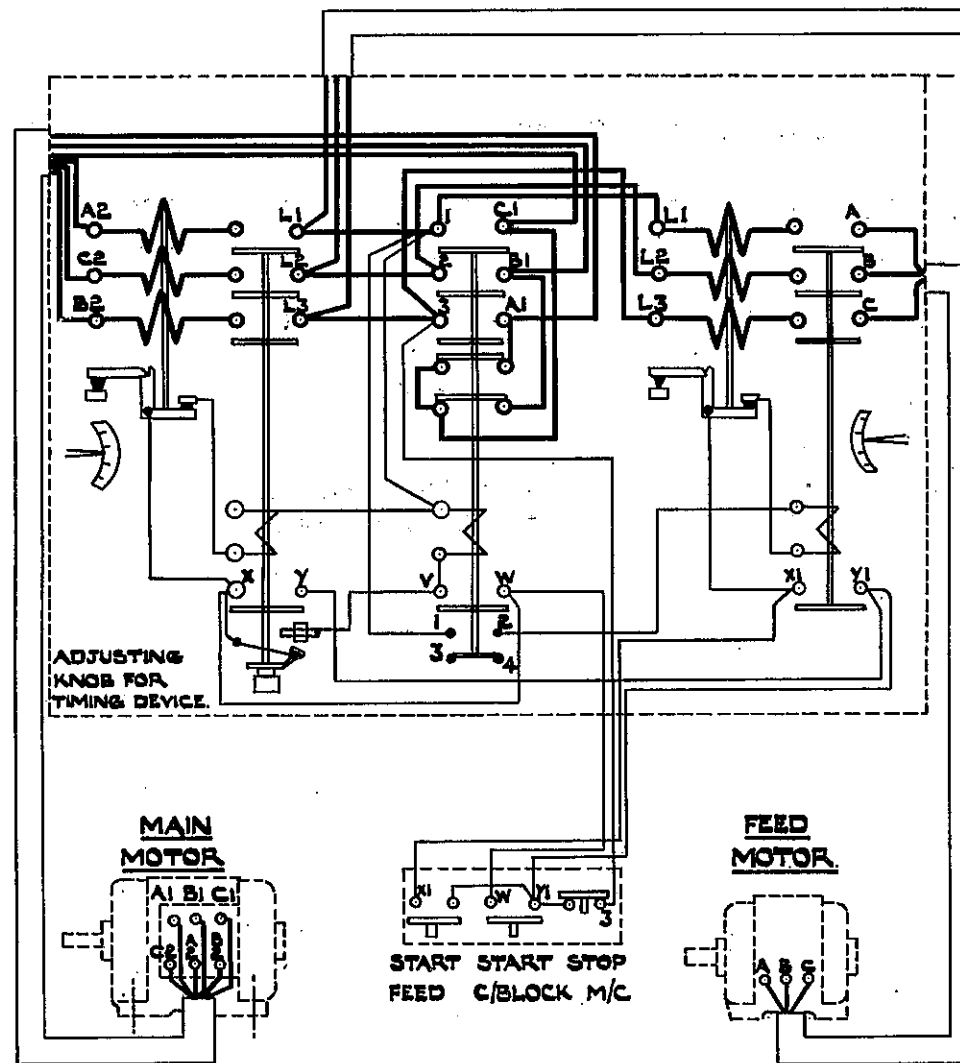

Fig. 13

RETAIN THIS DIAGRAM FOR FUTURE REFERENCE

FOR PARTICULARS OF WADKIN PORTABLE ELECTRIC BLOWER FOR CLEANING DOWN M/C & ELECTRICAL GEAR SEE LEAFLET N° 687



SUPPLY PARTICULARS	
VOLTAGE	
PHASE	
FREQUENCY	
OUTPUT	

INSTALLATION INSTRUCTIONS.

MAINS.

FIT TRIPLE POLE ISOLATING SWITCH NEAR MACHINE SO THAT THE ELECTRICAL GEAR MAY READILY BE ISOLATED FOR INSPECTION PURPOSES. BRING LINES TO L1, L2, L3 THROUGH CONDUIT WHICH SHOULD BE SECURED TO THE MACHINE BY MEANS OF LOCKNUTS. FILL STARTER TANK TO INDICATED OIL LEVEL WITH OIL PROVIDED. CHECK POSITION OF CONTACTS. ENSURE THAT DIRECTION OF ROTATION IS CORRECT BEFORE OPERATING MACHINE TO REVERSE DIRECTION OF BOTH MOTORS INTERCHANGE L1 & L2.

OVERLOAD.

THE SETTING OF THE OVERLOAD UNITS MAY BE VARIED BY MEANS OF THE ADJUSTMENT POINTERS. NORMAL SETTING IS TO THE MARKS CORRESPONDING TO THE FULL LOAD MOTOR CURRENTS. SHOULD THE MOTOR STOP DUE TO OVERLOAD, WAIT A SHORT TIME TO ALLOW THE RELAYS TO COOL & THEN START IN THE USUAL MANNER.

ADJUSTMENT OF TIMING DEVICE.

SHOULD THE CONTACTOR CHANGE OVER FROM "STAR" TO "DELTA" BEFORE THE MOTOR IS UP TO SPEED, TURN THE RED ADJUSTING KNOBS IN AN ANTI-CLOCKWISE DIRECTION & VICE-VERSA TO DECREASE THE TIME.

MASTER STOP BUTTON

A MASTER STOP BUTTON IS PROVIDED WHICH IS FITTED WITH A LOCK OFF FEATURE THIS MUST BE RELEASED BEFORE A START CAN BE MADE.

MAINTENANCE.

1. RENEW OIL YEARLY.
2. RENEW CONTACTS & SPRINGS ONCE EVERY 2 YEARS

EARTH MACHINE.

NOTE. MAIN MOTOR MUST BE RUNNING BEFORE FEED MOTOR CAN BE STARTED.

**WADKIN LTD.
LEICESTER.**

DIAGRAM OF CONNECTIONS.

D. 203/1.

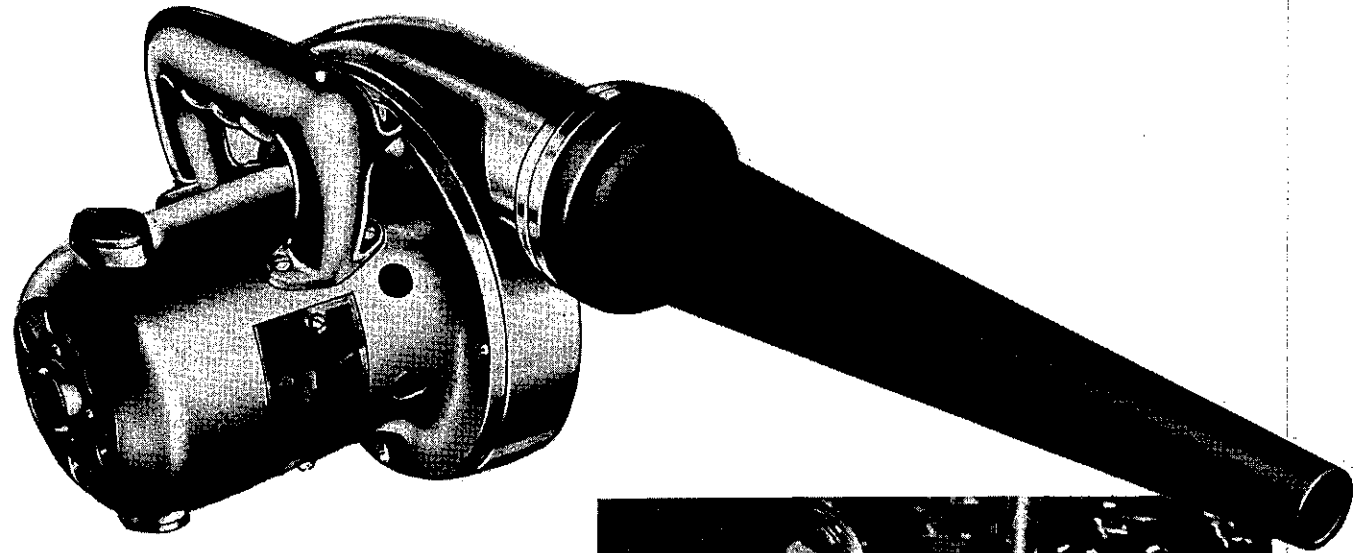

... blow away harmful dust, chips and dirt with a Wadkin Electric Blower

No motor can run at its maximum efficiency with its ventilating duct or control gear covered with dust and dirt. Sooner or later the resultant overheating will cause serious trouble.

Similarly, accumulations of chips and dust, in the mechanical parts of the machine can interfere with its efficiency. A few minutes a week for blowing down all Woodworking Machinery will be amply repaid in better and easier running, in increased life, and freedom from breakdown.

Blowers can be supplied for single phase A.C. or Direct Current for any voltage up to 250.

Please state voltage when ordering.

